

Conzerv EM6438_EM6436 Dual Source Energy Meters User Manual

NHA12537-03
07/2015



Hazard Categories and Special Symbols

Read these instructions carefully and look at the equipment to become familiar with the device before trying to install, operate, service or maintain it. The following special messages may appear throughout this manual or on the equipment to warn of potential hazards or to call attention to information that clarifies or simplifies a procedure.

SAFETY SYMBOLS



The addition of either symbol to a “Danger” or “Warning” safety label indicates that an electrical hazard exists which will result in personal injury if the instructions are not followed.

This is the safety alert symbol. It is used to alert you to potential personal injury hazards. Obey all safety messages that follow this symbol to avoid possible injury or death.

SAFETY MESSAGES

DANGER

DANGER indicates a hazardous situation which, if not avoided, **will result in** death or serious injury.

WARNING

WARNING indicates a hazardous situation which, if not avoided, **could result in** death or serious injury.

CAUTION

CAUTION indicates a potentially hazardous situation which, if not avoided, **could result in** minor or moderate injury.

CAUTION

CAUTION used without the safety alert symbol, indicates a potentially hazardous situation which, if not avoided, **can result in** property damage.

NOTICE

NOTICE is used to address practices not related to physical injury.

OTHER SYMBOLS



This symbol indicates direct and alternating currents

This is double insulation symbol which indicates that, the user-accessible area is protected throughout by double insulation or reinforced insulation.

PLEASE NOTE

Electrical equipment should be installed, operated, serviced, and maintained only by qualified personnel. No responsibility is assumed by Schneider Electric for any consequences arising out of the use of this material.

Chapter 1 – Product Description.....	6
Physical Description	6
Front Panel	7
Rear Panel	12
Models and Parameters.....	13
Technical Specifications	14
Chapter 2: Safety Precautions	16
Chapter 3: Quick Start Guide	17
PROG Menu — Setup	17
Quick Setup – While powering ON	17
Enter Setup Menu in View (Read-Only) Mode.....	19
Enter Setup Menu in Edit Mode	19
Setup Parameters in View and Edit Modes	20
Setup Parameters in View and Edit Modes (continued)	21
Edit Set Parameters	22
Clear Maximum Demand (MD)	24
Energy Integrator	25
User-programmable Integrator names.....	25
Integrator Overflow	25
OLD Data Register.....	26
Demand Power Calculation Methods	27
Dual Source Energy Meters Menu Hierarchy	28
Menu Hierarchy.....	28
Menu Hierarchy (Continued).....	29
EM6436Dual Dual Energy Meter Menu Hierarchy	Error! Bookmark not defined.
Menu Hierarchy.....	30
Menu Hierarchy (Continued).....	31
Menu Hierarchy (Continued).....	32
Chapter 4: AC Power Measurement.....	33
3-Phase Systems.....	33
Consumption and Poor Power Factor	34
“3D” kVA Measurement	34
Chapter 5: Installation	35
Mechanical Installation	35
Installation Procedure	36
Electrical Installation	38
Terminal connections using lugs	39
Auxiliary Supply (Control Power)	40
PTs (VTs) and CTs	40
Voltage Signal Connections.....	41
Current Signal Connections.....	41
Setup — System Type	43
Phase Labels	43
Connection Diagrams	43
G Sense Wiring.....	47
Chapter 6: Data Communication.....	49
Float Byte Register	49
Health Check Register	49
Float Byte Order Detection	49
RS 485 Data Port.....	50
Installation.....	50
Communication Capabilities	51
Daisy-chaining Devices to the Dual energy meter.....	51
Data Formats and Settings	52
Modbus Standard Device Identification	53
Parameter Settings for Different SCADA Software	53
Communication Test	54
Data Address	55
Chapter 7: Maintenance and Troubleshooting	67
Introduction	67

Troubleshooting	68
Disposal and Recycle	69
To Disassemble	69
Appendix A – Technical Data	70
Accuracy	70
Auxiliary supply (Control power)	70
Front Panel Display	70
Installation and Input Ratings	71
Environmental Conditions.....	71
Construction.....	71
Dimensions and Shipping	71
Appendix B: SIM (simulation) Mode	72
Appendix C: Glossary	73
Terms.....	73
Abbreviations	74
INDEX	75

Chapter 1 – Product Description

The EM6438_EM6436 dual source energy meters are digital dual meters that offer comprehensive 3-phase electrical instrumentation and load management facilities in a compact and rugged package for the dual source energy Utility (U) and Generator (G).

This chapter contains the main operating instructions. The remaining chapters explain the installation and setup steps required before the dual energy meter is ready for use, and maintenance and troubleshooting procedures for the dual energy meter after installation.

The dual energy meter is a universal dual energy meter. Before use, please program the SYS (measurement system configuration) and the PT (VT) and CT ratios through the front panel keys. Otherwise, it will read your system incorrectly. Other settings, such as communication parameters, must also be programmed as needed.

Schneider Electric stands behind your EM6438_EM6436 dual energy meters with complete user support and service.

Intended use: The dual energy meter is designed for use in industrial and commercial installations by trained and qualified professionals, not for domestic use.

Physical Description

FRONT: The front panel has three rows of four digits/characters each, with auto scaling Kilo (K), Mega (M), and minus (-) indications. The **K** and **M** indicators are lit together to show Giga readings. The load bar graph to the right of the display gives the indication of consumption in terms of the % amperes load with respect to the full scale (FS) selected. Five smart keys make navigating the parameters very quick and intuitive for viewing data and configuring the dual energy meter.

REAR: The voltage and current terminals and the RS 485 communication port are located on the back of the dual energy meter. Refer to “Rear Panel” on page 13 for more information.

BOTTOM: G sensing terminals are located at the bottom of the dual energy meter.

Front Panel

The front panel contains the following indicators and controls:

- **Eight-segment LED display:** Three rows of alphanumeric displays, four digits each, display three RMS parameters simultaneously or one energy parameter. The displayed readings update every second.
- **Analog load bar:** Unique indication of % load with respect to the full scale (FS).
- **Indicators:** For each row Kilo, Mega (Kilo + Mega = Giga) indicators, and a Negative (-) indicator.
- **Keys:** Five smart keys to scroll through the display pages.

Figure 1-1: Parts of dual source energy front panel

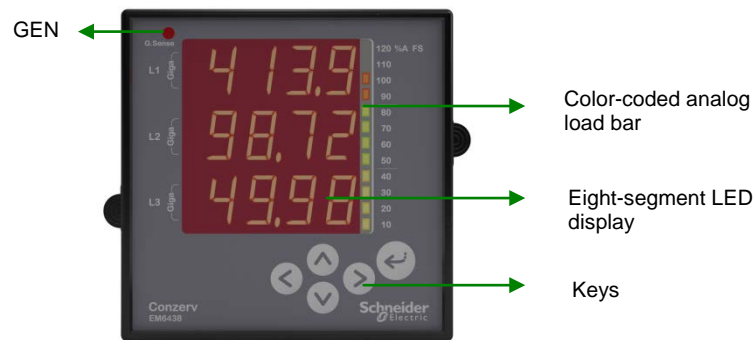

Eight-segment LED display

- Four line, three digits, eight-segment LED display.
- The dual energy meter displays the parameter name prominently right on the large, alphanumeric readouts.
- The dual energy meter displays the parameter name for **two** seconds and then the value for **eight** seconds. The parameter name is also displayed each time when you press a key. This helps the user to know which parameter is currently displayed.
- This method also allows programmable phase soft-Labels in the dual energy meters. You can choose from 123 (factory setting), ABC, RYB, PQR or RST.

Analog Load Bar

- Unique indication of total load % with respect to the full scale through the 12 LEDs at the right side of the display.
- This is bar graph, where each LED indicates 10% of load.
- To find the total load, count the number of illuminated LEDs, and then multiply by 10.

Table 1-1: Load percentage and bar graph indication

Load percentage	Bar graph display
Less than 10%	No LEDs are lit.
Between 10 to 40 %	Amber LEDs are lit.
Between 50 to 80%	Green LEDs are lit to indicate that the load is acceptable and should not be increased further.
Above 80%	Red LEDs are lit to indicate that the load has exceeded the sanctioned limit and is dangerous.

The Indicators – Kilo, Mega, and Negative

Table 1-2 Indicators





	Kilo: When lit, indicates that the reading is in Kilo (10^3). 10,000 is displayed as 10.00 K and 1.0 K as 1000.
	Mega: When lit, indicates that the reading is in Mega, (10^6). 10,000 K is shown as 10.00 M and 1.0 M as 1000 K.
	Giga: When Kilo and Mega are lit together, the reading is in Giga (10^9). 10,000 M is shown as 10.00 G and 1.0 G as 1000 M.
	Negative: When lit, indicates that the reading is negative as per IEEE 100 and industry standard practice. When PF (power factor) is lead (capacitive load): Both PF and VAR (reactive power) signs will be negative. When current is reversed: W (active power) is negative.
	GEN: Indicates generator running, if used for generator application. Indicates gated load (ON load), if used for industrial application. Indicates greater load (peak load), if used for dual tariff application.

Table 1-3: Giga, Mega (M), Kilo (K), and decimal point scaling

RMS Reading	Indicator
Less than 0.001	K, M OFF, displays 0.000
Less than 9999	K, M OFF
Above 9999	K ON, M OFF
Above 9999 K	M ON, K OFF
Above 9999 M	Giga (K + M indicators ON)
Up to 9999 G	Giga
Above 9999 G	Display shows Hi for positive numbers, Lo for negative numbers





RMS readings are four digits. Energy readings have eight digits, including four additional fractional digits. The maximum number the dual energy meter handles is 9,999 G for RMS and energy values.

This means that the energy readings of the dual energy meter will overflow at three values of Wh (active energy) or VAh (apparent energy) (selectable through PROG menu - setup) depending upon the PT (VT) and CT ratios programmed.

Smart Keys

Operating the dual energy meter is easy, using the five smart keys to navigate through the display pages. The display pages **expand** as you go to the right, much like the directory or explorer **tree** displayed on any computer. The display shows where you're headed.

Table 1-4: Smart keys description

	<p>Right Key</p> <ul style="list-style-type: none"> • Go forward into sub-parameter pages. • Going right past EDIT in SET and CLR requires code entry to enter PROG menu (setup and clear). • During setup, select next (right side) digit.
	<p>Left Key:</p> <ul style="list-style-type: none"> • Go back towards to the main parameter pages. • During edit setup, selects previous (left side) digit. • Exits from Edit mode, back to the PROG menu – setup. • The meter enters the SIM (simulation) mode when you press the left key continuously during the power up of the dual energy meter. See • “SIM (Simulation) mode” on page 77 for more information.
	<p>Up Key:</p> <ul style="list-style-type: none"> • Scroll up through display pages at the same level, within the same function. <ul style="list-style-type: none"> • Continuous pressing for three seconds initiates limited auto-scroll (within the same function). See “Auto-scroll” on page 12 for more information. • While editing, increases the value of the blinking/selected digit.
	<p>Down Key:</p> <ul style="list-style-type: none"> • Scroll down through other display pages at the same level, through all functions. <ul style="list-style-type: none"> • Continuous pressing for three seconds initiates the full auto-scroll mode, through all functions. See “Auto-scroll” on page 12 for more information. • While editing, decreases the value of the blinking/selected digit.
	<p>TURBO Key:</p> <ul style="list-style-type: none"> • TURBO key is simple one touch access to the most commonly used parameters pages (factory set). The TURBO pages for dual energy meters are given below. • The TURBO key scrolls through Wh.U, Wh.G or VAh.U, VAh.G. • TURBO key to quickly return the RMS page. If you're lost, the TURBO key is a quick way to get back to the RMS home page. • Continuous pressing for three seconds initiates auto scrolling through the above TURBO pages. See “Auto-scroll” on page 12 for more information. • During the power up, if the TURBO key is pressed, the dual energy meter goes directly in to PROG menu – Setup. This is the easiest way to enter into the setup menu. See “Quick setup – While powering on” on page 19 for more information.

Keypad Operation

Press the key in the direction you want to go. The display shows where you're headed. Press the key that takes you in the desired direction.

The following example explains how to navigate from the **RMS** page to the **VLN A F** page and back to the **RMS** page in the EM6436dual dual energy meter.

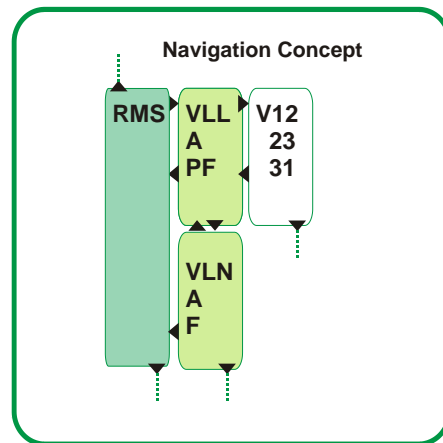

1. From the **RMS** page, press . The display shows **VLL**
A
PF
2. Press . The display shows **VLN**
A
F
3. To return to **RMS**, press . The display shows **RMS**.

Use to go forward to the sub-parameter page and use to go backward to the main parameter pages. Use and to scroll up and down through the display pages.

Auto-scroll

Auto-scroll allows you to monitor a group of display pages sequentially, every five seconds, without constant key pressing. This is convenient for viewing from a distance. The dual energy meter shows the parameter name for **one second** followed by the value for **four seconds**.

- **To auto-scroll within a page group (e.g., Within RMS group)**

Go to a particular page in the desired page group. Press  continuously for three seconds and then release. The display flashes **AUTO** and starts auto-scroll within the page group.

- **To auto-scroll down the entire column of pages**

Go to the desired page. Press  continuously for three seconds and then release. The display flashes **AUTO** and starts auto-scroll down the entire column of pages.

- **To auto-scroll through TURBO pages**



Press  continuously for three seconds and then release. The display flashes **AUTO** and starts auto-scroll through the TURBO pages.

NOTE: Press any key to revert to manual scrolling. Auto scrolling is not possible in the setup parameters.



Default Display (View) Page

You can select any page as a **user-set** default display page. You can scroll to other display pages. The **user-set** page is displayed two minutes after the manual scrolling is stopped by the user.

To lock the user-set default page:

- Go to the page you want to set as the default page.
- Press  and  simultaneously to lock the page. The dual energy meter displays **LOCK**.

To unlock the user-set default page:

- Once the default display page is active, press  and  simultaneously to unlock the page. The dual energy meter displays **ULOC**.

*NOTE: Entry into setup (PROG) is allowed only when the **display page** is unlocked.*

Default Display Page through Communication

- You can lock and unlock the default display page through communication.
- If the default display page is locked by operator through communication, the default display page can be unlocked through front panel.
- If the default display page is locked by supervisor through communication, the operator cannot unlock the default display page through front panel and communication. Only supervisor can unlock through communication.

Rear Panel

The dual energy meter terminals are located on the rear panel. 14 terminals are provided, seven terminals on each side:

- Six terminals for current, one **in** and one **out** per phase.
- Four terminals for voltage, for three phases and neutral.
- Two terminals for auxiliary power supply (control power).
- Two terminals for the RS 485 communication port.

Figure 1-2: Rear panel

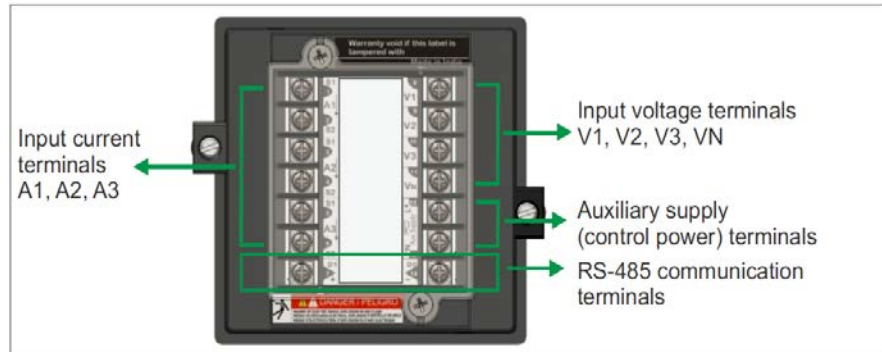

Models and Parameters

The dual energy meter can measure, locally display, and remotely transfer over Modbus RTU protocol, the following parameters:

Table 1-5: Models and parameters

Parameter		EM 6438	EM 6436 dual
RMS	VLLV12, V23, V31 VLN V1, V2, V3	-	✓
	A A1 A2 A3	-	✓
	F	-	✓
	PF PF1 PF2 PF3	-	✓
	%A FS Analog color coded load bar	✓	✓
	W W1 W2 W3	✓	✓
DM	Demand VA/ W/ A (selectable through setup)	<input type="checkbox"/>	<input type="checkbox"/>
	Rising demand	<input type="checkbox"/>	<input type="checkbox"/>
	Time remaining	<input type="checkbox"/>	<input type="checkbox"/>
	Maximum Demand (MD) U and G	<input type="checkbox"/>	<input type="checkbox"/>
	Hr MD occurred	<input type="checkbox"/>	<input type="checkbox"/>
INTG and OLD U	Wh.U	✓	✓
	Run.U	✓	✓
	On.U	✓	✓
INTG and OLD G	Wh.G	✓	✓
	Run.G	✓	✓
	On.G	✓	✓
INTG and OLD TOT	t.Wh	✓	✓
	t.Run	✓	✓
	t.On.h	✓	✓
	RS 485	✓	<input type="checkbox"/>

NOTE:

- ✓ – Standard; – Option specified while ordering.

The dual source energy meter displays:

- **Voltage (EM6436dual):** Three voltage measurements line-to-line: 1-2, 2-3, 3-1, and average, Three voltage measurements line-to-neutral: 1-4, 2-4, 3-4, and average.
- **Current (EM6436dual):** Three current measurements phase-wise (1, 2, 3), average current of all three phases.
- **Frequency (EM6436dual):** Measures from whichever phase is active.
- **Power:** W per phase and total. PF per phase and average. Per-Phase W readings provide a quick CT Polarity Check. A negated W phase reading indicates CT reversal.
- **Energy:** Wh.U, On.U, Run.U, Wh.G, On.G, Run.G, t.Wh, t.On.h, t.Run, Wh, VAh.
- **Energy (OLD):** Wh.U, On.U, Wh.G, On.G, t.Wh, t.On.h.
- **% Amperes load bar graph:** Load bar graph indicates consumption in terms of % amperes total. You can quickly estimate the load by viewing the display without operating any keys. The bar graph consists of 12 segments. Each segment indicates a current load of 10% of CT primary.
- **Kilo, Mega, Giga** indications for the above parameters. See “The Indicators” on page 9 for more information.

Technical Specifications

The dual energy meters are high-accuracy, low cost, ultra-compact, power, and dual energy meter. It offers ISO 9001 quality, accuracy, and functional flexibility. Selective models of this series have Modbus RTU communications capability. The standard unit flush-mounts in a DIN 96 cutout and conforms to UL product standards.

The dual energy meters are designed to monitor dual sources/energy Utility (U) and Generator (G). Each can be used as a standalone meter in electrical control panels, power distribution units (PDU), switch boards, uninterrupted power supplies (UPS), generator sets, and motor control center (MCC) systems. It also provides easy communication to program logic control (PLC), distributed control systems (DCS), building management systems (BMS), and other systems.

The following table gives the technical specifications of the dual energy meters. Refer to “Technical Data” on page 75 for more information.

Table 1-6: Technical specifications

Description	Specification
Sensing/Measurement	True RMS, one second update time, four quadrant power and two quadrant energy.
Accuracy	Class 1.0 as per IEC 62052-11 and IEC 62053-21; Class 0.5S (Optional) as per IEC 62052-11, 62053-22 ; Class 0.2*(Optional)
Auxiliary supply (Control power)**	44 to 300 VAC/DC CAT III 50/60 Hz
G smart sensing	18 to 60 VDC / 80 to 300 VAC
Burden	Voltage and current input < 0.2 VA per phase Auxiliary supply (Control power) < 3 VA at 240 V, 5 VA Max < 2 W at 300 V DC DG-sense input burden: < 0.5 VA at 300 V AC
Display	Alphanumeric bright LED
Resolution	RMS four digits, INTG eight digits
Input voltage	Four voltage inputs (V1, V2, V3, VN) IEC: 80 to 480 V-LL (50 to 277 V-LN) CAT III 80 to 600 V-LL (50 to 350 V-LN) CAT II UL: 80 to 600 V-LL
Input current*** (Energy measurement)	Current inputs (A1, A2, A3); 5 A Class 1.0/0.5S: 5 mA (starting) to 6 A 5 A Class 0.5S/0.2: 5 mA (starting) to 6 A 1 A Class 0.5S/0.2: 1 mA (starting) to 1.2 A
Frequency	45 to 65 Hz
Overload	5 A meter: 10 A max continuous, 50 A for 5 sec/hr, 120 A for 1 sec/hr 1 A meter: 2 A max continuous, 10 A for 5 sec/hr, 24 A for 1 sec/hr
Environmental	Operating temperature: -10 °C to 60 °C (14 °F to 140 °F) Storage temperature: -25 °C to +70 °C (-13 °F to 158 °F) Humidity 5% to 95% non condensing Altitude ≤ 2000m
Standard	CAT III - Measurement category III, Pollution Degree 2,  - Double insulation at user-accessible area
Weight	400 gms approx, unpacked 500 gms approx, shipping
Communication (optional)	RS-485 serial channel connection Industry standard Modbus RTU protocol
The dual energy meters conform to	Emission : CISPR22 Class A; Fast Transient: 4kV IEC 61000-4-4; Surge withstand: IEC 61000-4-5; Damped Oscillatory: IEC 61000-4-12; ESD: IEC 61000-4- 2;

	Impulse voltage: 6 kV, IEC 60060, 1.2/50 μ s
IP degree of protection	Front display – IP 51; Meter body – IP 40 Excluding terminals

NOTE: Universal CT range is applicable for Class 1 & Class 0.5 meters where CT secondary of 1 A or 5 A is field-programmable.

For Class 0.5S & Class 0.2 meters, CT secondary rating (1 A or 5 A) should be specified while ordering.

* Class 0.2 is applicable when the voltage (line-neutral) is above 120 V.

** Auxiliary voltage should not exceed 300 V AC/DC

*** Additional error of 0.05% of full scale, for dual energy meter input current below 100mA for 5A and below 20mA for 1A.

Chapter 2: Safety Precautions

This section contains important safety precautions that must be followed before attempting to install, service, or maintain electrical equipment. Carefully read and follow the safety precautions outlined below.

DANGER

HAZARD OF ELECTRIC SHOCK, EXPLOSION, OR ARC FLASH

- Apply appropriate personal protective equipment (PPE) and follow safe electrical work practices. In the USA, see NFPA 70E.
- Only qualified electrical workers should install this equipment. Such work should be performed only after reading this entire set of instructions.
- If the equipment is not used in a manner specified by the manufacturer, the protection provided by the equipment may be impaired.
- NEVER work alone.
- Before performing visual inspections, tests, or maintenance on this equipment, disconnect all sources of electric power. Assume that all circuits are live until they have been completely de-energized, tested, and tagged. Pay particular attention to the design of the power system. Consider all sources of power, including the possibility of back feeding.
- Turn off all power supplying the dual energy meter and the equipment in which it is installed before working on it.
- Always use a properly rated voltage sensing device to confirm that all power is off.
- Before closing all covers and doors, inspect the work area for tools and objects that may have been left inside the equipment.
- When removing or installing panels do not allow them to extend into the energized bus.
- The successful operation of this equipment depends upon proper handling, installation, and operation. Neglecting fundamental installation requirements may lead to personal injury as well as damage to electrical equipment or other property.
- NEVER bypass external fusing.
- NEVER short the secondary of a PT.
- NEVER open circuit a CT; use the shorting block to short circuit the leads of the CT before removing the connection from the dual energy meter.
- Before performing Dielectric (Hi-Pot) or Megger testing on any equipment in which the dual energy meter is installed, disconnect all input and output wires to the dual energy meter. High voltage testing may damage electronic components contained in the dual energy meter.
- Before wiring ensure that DG signal source is de-energized.
- Ensure that no wiring strands are straying out by firmly connecting two sensing wires to the female euro connector.
- The dual energy meter should be installed in a suitable electrical enclosure.
- RS 485 is safe to access up to 277 L-N / 480 L-L V only. If the voltage is above 277 L-N / 480 L-L V, then switch OFF the input voltage before handling the RS 485 terminal.

Failure to follow these instructions will result in death or serious injury

Chapter 3: Quick Start Guide

PROG Menu — Setup

- The dual source energy meter must be configured to match the application settings, before use. Otherwise, the readings will be incorrect.
- All the setup values can be re-programmed at any time, using **SET**. However, the settings: SYS (WYE (Star)/Delta/single-phase / 2-Phase), Vpri, Vsec, Apri, Asec critically determine the scaling of measured readings.
- The scaling may be used to reduce the errors in readings due to Instrument Transformer errors. However, incorrect settings will introduce errors in readings of other running systems.

⚠ CAUTION

HAZARD OF UNINTENDED OPERATION

Only qualified personnel are authorized to set up the dual energy meter.

Failure to follow this instruction can result in injury or equipment damage.

You can enter the PROG menu - setup in

- **View only mode:** To view the set parameters.
- **Edit mode:** To view or edit set parameters.

Quick Setup – While powering ON

- This is the easiest way to enter the PROG menu setup.
- To make connections, see “Connection Diagrams” on page 46. Here are few tips.

Figure 3-1: Quick setup - connections

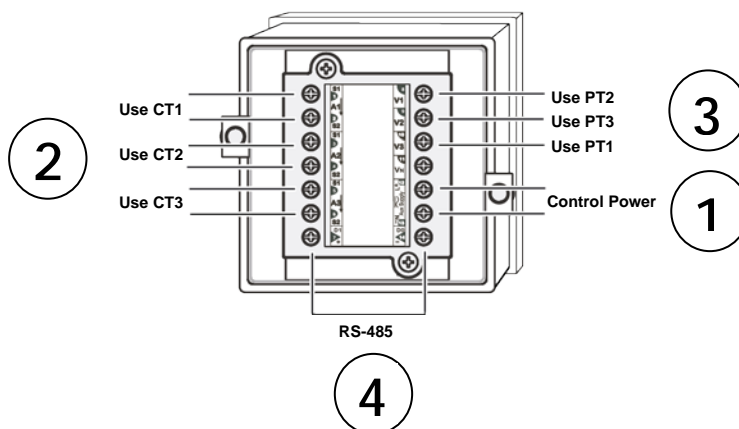

1. Connect auxiliary supply (control power) 44 to 300 VAC/DC to terminals 12 and 13 in order to power ON the dual energy meter.

- Keep  pressed for two seconds, while powering up the dual energy meter. The dual energy meter enters directly into PROG menu setup and displays **EDIT A.PRI 100.0**.

Program the following setup parameters for accurate readings:

- **A.pri, A.sec:** Set these values to match your CT primary and secondary values. For example, if your CT ratio is 200:5, set A.pri = 200.0 and A.sec = 5.000.

- **V.pri, V.sec:**

- Set these values to match the input voltage VLL of circuit, if the input voltage < 600 VAC LL. For example, if input voltage = 300 VAC LL, set V.pri = 300.0 and V.sec = 300.0.
- Use potential transformer (PT/VT), if the input voltage > 600 VAC LL. Set the V.pri and V.sec values to match the primary and secondary of the PT(VT) respectively. For example, if PT(VT) ratio is 11 kV: 110, set V.pri = 11.00 k and V.sec = 110.0.

Select one of the following systems according to your wiring configuration:

- SYS: DLTA for 3-phase 3-wire system
- SYS: WYE/Star for 3-phase 4-wire system
- SYS: 2-phase for 2-phase 3-wire system
- SYS: single-phase for single-phase 2-wire system

2. Connect the current transformers (CTs).

CT1	CT2	CT3
1, 2	3, 4	5, 6

3. Connect the voltage inputs. Use PT (VT), if voltage exceeds 600 VAC LL.

PT1	PT2	PT3	Neutral
8	9	10	11

4. RS 485 terminals

+ve	-ve
7	14

Enter Setup Menu in View (Read-Only) Mode

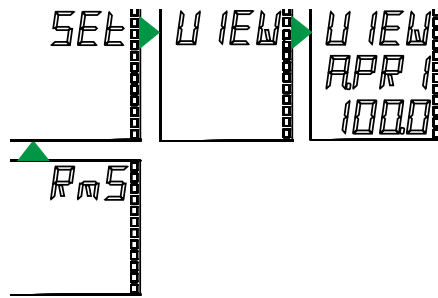

1. From **RMS**, press . The display shows **SET**.
2. Press . The display shows **VIEW**.
3. Press . Use and to scroll and view the setup parameters and their current settings.

Enter Setup Menu in Edit Mode

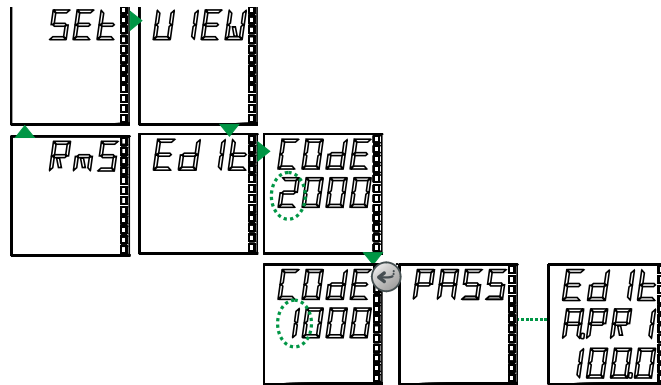

NOTE: means blinking
 Means blinking 2

1. From **RMS**, press . The display shows **SET**.
2. Press . The display shows **VIEW**.
3. Press . The display shows **EDIT**. **CODE** entry is required to enter the setup menu in edit mode.
4. Press for two seconds. The display shows **CODE 2000** with **2** blinking. The factory set code is **1000**.
5. Press . The display shows **CODE 1000** with **1** blinking.
6. Press once or four times to accept the new **CODE** value. The display shows **PASS** and then **EDIT A.PRI 100.0** indicating the successful entry to the setup menu in edit mode.

NOTE: If you enter an incorrect code, the display flashes **FAIL**, and then displays **EDIT**. Repeat the procedure and make sure that you enter correct code.

Setup Parameters in View and Edit Modes

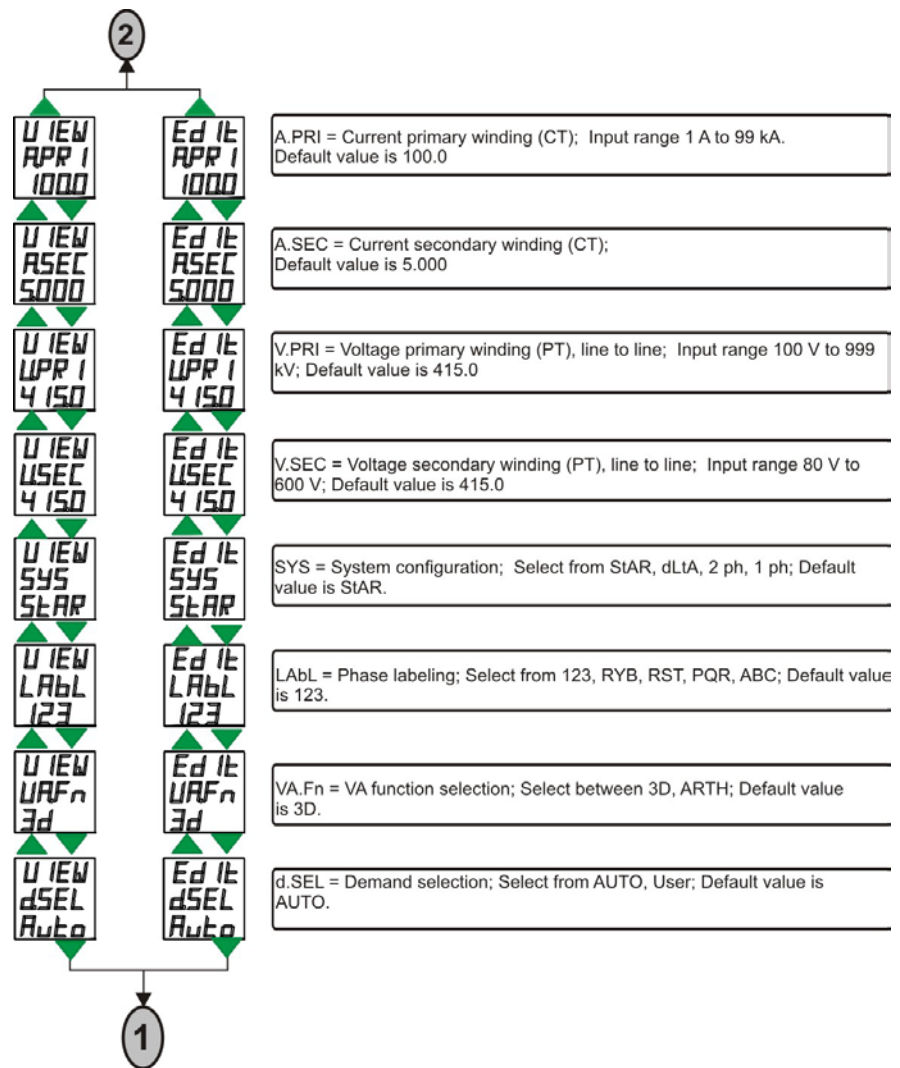

NOTE:

- BAUD, PRTY, and ID are applicable only for dual energy meters with RS 485 communication option.
- DMD parameters are available only for dual energy meters with demand option.

Setup Parameters in View and Edit Modes (continued)

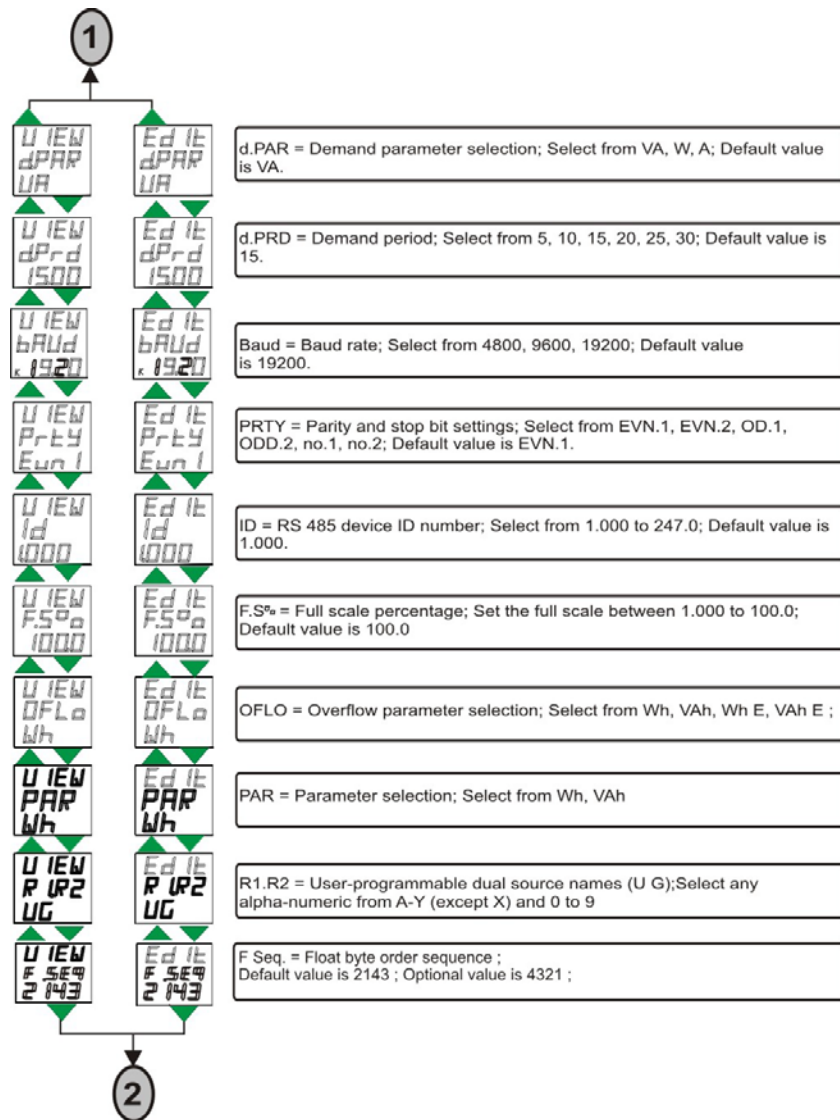

NOTE:

- BAUD, PRTY, and ID are applicable only for dual energy meters with RS 485 communication option.
- DMD parameters are available only for dual energy meters with demand option.



Edit Set Parameters



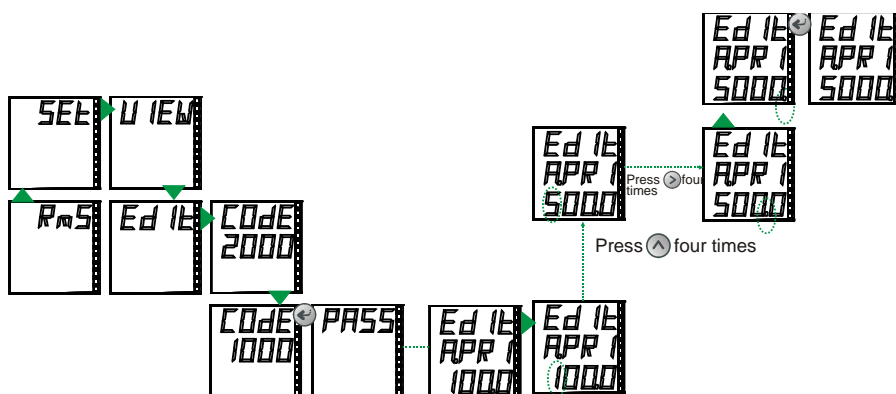

This example explains how to edit the value of **A.PRI** from **100.0** to **5000** in PROG menu setup of the dual energy meter. Then it explains how to save the new value to the setup.

NOTE: After entering into setup, the dual energy meter exits from the setup automatically, if there is no key press for > 2 min.

Edit and Accept Setup



NOTE:  means blinking
 Means blinking 2

1. After you have successfully entered setup menu in edit mode, (Refer to “Enter setup menu in Edit mode” on page 21 for more information) press . The display shows **EDIT A.PRI 100.0** with blinking **1**. This indicates that the value can be edited.
2. Press  for four times. The display shows **EDIT A.PRI 500.0** with blinking **5**. The value can be edited.
3. Press  four times. The display shows **EDIT A.PRI 500.0** with blinking “.”.
4. Press . The display shows **EDIT A.PRI 5000.** with blinking “.”.
5. Press  to accept the new value.

To edit the next parameter, press  and repeat the above steps.

Save the New Value to Setup

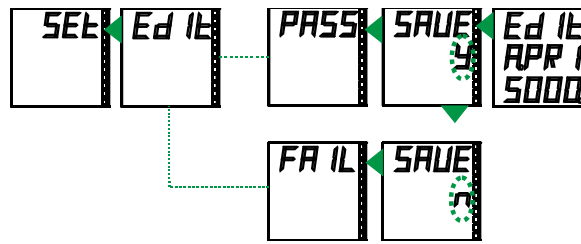

NOTE: *y* means blinking
y means blinking y

1. After you edit the parameter as described above, press . The display shows **SAVE y** with blinking **y**.
2. Press or to save the new value. The display flashes **PASS** and then shows **EDIT**.
3. Press to return to **SET**.

NOTE: If you do not want to save the new value, press to change the value from **SAVE y** to **SAVE n** in step 1. Then press or . The display flashes **FAIL** and shows **EDIT**. Proceed to step 3.

Edit ID

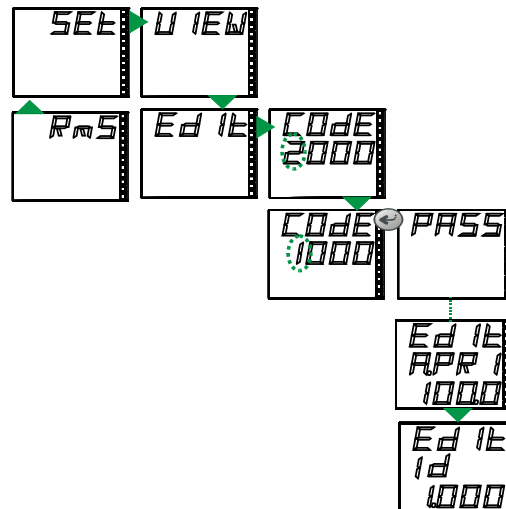



NOTE: *y* means blinking
y means blinking y

1. From **RMS**, press . The display shows **SET**.
2. Press . The display shows **VIEW**.
3. Press . The display shows **EDIT**.
4. Press for two seconds. The display shows **CODE 2000** with **2** blinking. The factory set **CODE** is **1000**.
5. Press . The display shows **CODE 1000** with **1** blinking.
6. Press once or four times to accept the new **CODE** value.

The display shows **PASS** and then **EDIT A.PRI 100.0** indicating the successful entry to the setup menu in edit mode.

7. Press  until the display shows **EDIT ID 1.000** page.



Press  to set the desired **EDIT ID** value. Press  to view the **Edit ID** page set with the new values.





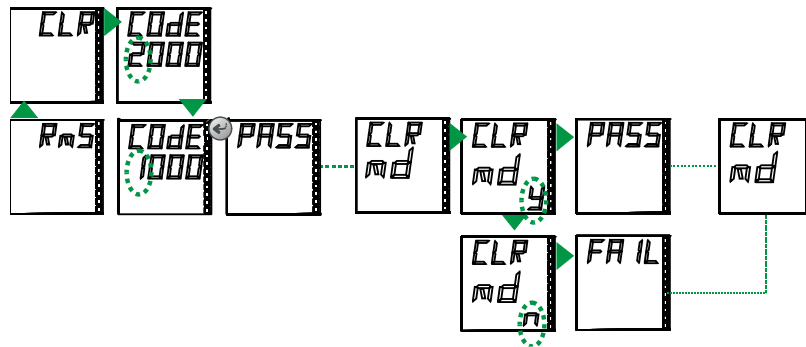



NOTE: If you enter a wrong code, the display flashes FAIL and then displays EDIT. Repeat the procedure and make sure that you enter correct code.

Clear Maximum Demand (MD)

This section is applicable for dual energy meters with demand option.



NOTE:  means blinking
 means blinking y

1. From **RMS**, press . The display shows **CLR**.
CODE entry is required to clear the **MD** values.
2. Press  for two seconds. The display shows **CODE 2000** with blinking **2**. The factory set **CODE** is **1000**.
3. Press . The display shows **CODE 1000** with blinking **1**.
4. Press  once or  four times to accept the new value.
After the successful **CODE** entry, the display shows **CLR MD**.
5. Press . The display shows **CLR MD y** with blinking **y**.
6. Press  to clear **MD**. The display flashes **PASS** and then **CLR MD**.
7. Press . The display shows **CLR**.
8. Press  to return to **RMS** page.

NOTE: If you do not want to clear the MD, press  to change the value from CLR MD y to CLR MD n in step 5. Then press . The display flashes FAIL and then show CLR MD. Proceed to step 7.

Energy Integrator

- The dual energy meter is equipped with an energy integrator function. It provides several parameters for energy management: Wh.U, ON.U, Wh.G, ON.G, t.Wh, t.On.h, and OLD registers.
- The integrator parameters are always accumulated irrespective of the parameter selected in the setup.
- All the values stored in the INTG are direct readings and have high resolution.
- The integrator parameters can be viewed by changing the PAR in the PROG menu – setup.

NOTE:

CT Reversal: Auto-correction for energy integration in star (wye) mode. In star (wye) mode energy integration always be in forward direction irrespective of the direction of current flow or sign of the power reading per phase.

User-programmable Integrator names

- The dual energy meter has two integrators with user-programmable names.
- You can program the alpha-numeric source names, for these integrators, from **A to Z** (except **X**) and **0 to 9**.
- By default these integrators are programmed with the names **U** and **G**.

Table 3-1: Integrator and applications

	GEN	TARIFF	INDUSTRIAL
U	Utility	Usual (off peak load)	Ungated (idle load)
G	Generator	Greater (peak load)	Gated (on load)

In all the above mentioned applications (GEN, TARIFF, INDUSTRIAL), the dual energy meter integrates the energy values normally in the **U** register. It integrates the values to **G** register only when the control input signal (10 to 60 VDC/80 to 300 VAC) for the generator is ON. The **G** sense LED at the front panel lights up when the generator is ON.

Integrator Overflow

- The energy values stored in INTG are based on V.Pri x A.Pri; they are independent of secondary values of V and A.
- The energy value readings will overflow based on V.Pri x A.Pri of the primary settings in setup, when Wh/VAh/Wh E/VAh E reaches 9999 K or 9999 M or 9999 G or when 9999 run hours is reached.
- The energy parameter for overflow is user selectable (Wh, Wh E or VAh VAh E) through setup. By default it is Wh E or by the Run hours which is fixed 9999 Run hours (almost 13.88 months).
- The values stored in the INTG are transferred to OLD register, during INTG overflow.
- For power systems ranging from 1 VA to 1000 MVA, the integrator will overflow at 9999 run hours. The duration required for the integrator to overflow will be 13.88 months if the dual energy meter is constantly running at full scale.
- However, in case of power systems greater than 1000 MVA, the integrator will overflow at a value less than 9999 run hours. The duration required for the integrator to overflow will be less than a year if the dual energy meter is constantly running at full scale.

Table 3-2: Integrator overflow

V.PRI x A.PRI x 1.732	Max reading (Wh.U + Wh.G)	Max time to reset the integrator in Run Hours	Minimum time to overflow in months at full scale
1 VA to 1000 VA	9999 K	9999	13.88
1 kVA to 1000 kVA	9999 M	9999	13.88
1 MVA to 1000 MVA	9999 G	9999	13.88
> 1000 MVA		<9999	<1 year

OLD Data Register

- The dual energy meters have an OLD data register, where the cleared INTG values are stored.
- The energy values in the integrator are transferred to the OLD register when the INTG is cleared (due to overflow). Thus the OLD energy values are not lost even after the integrator is cleared and can be viewed with the OLD parameter.

NOTE: For energy studies clear the Integrator at the end of each observation. This transfers all the stored energy values to the OLD register, where they are held while the Integrator begins accumulating data for the next observation. Remember that the next time the Integrator is cleared; the OLD values will be overwritten.

Demand Power Calculation Methods

This section is applicable only for the dual energy meters with demand option.

Demand power is the energy accumulated during a specified period divided by the length of that period. How the dual energy meter performs this calculation depending on the method you select. To be compatible with electric utility billing practices, the dual energy meter provides the following types of demand power calculations:

- Auto (sliding block)
- User (fixed block)

Auto (sliding block)

In the auto demand power calculation, you select an interval between five and 30 minutes in steps of five minutes. The demand calculation updates every 15 seconds.

Auto demand power calculation is the default calculation for dual energy meters.

User (fixed block)

In the user demand power calculation, you select an interval between five and 30 minutes in steps of five minutes. The demand calculation updates at the end of the interval. User demand power calculation can be selected through setup. See “Setup parameters in View and Edit modes” on page 22 for more information.

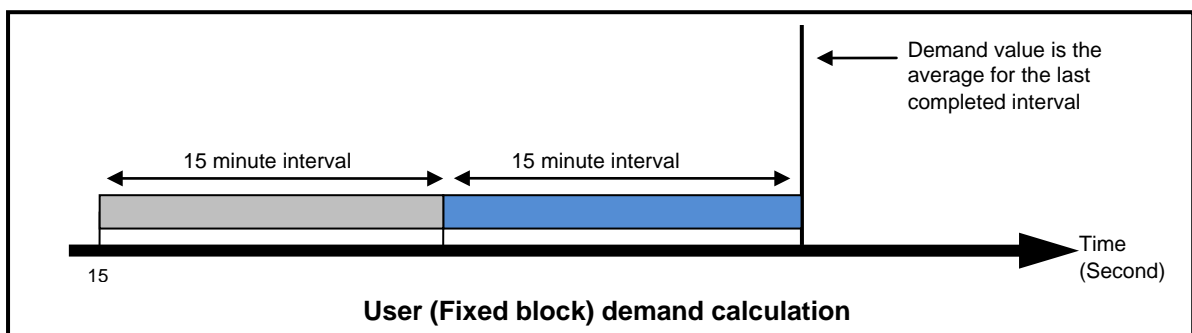
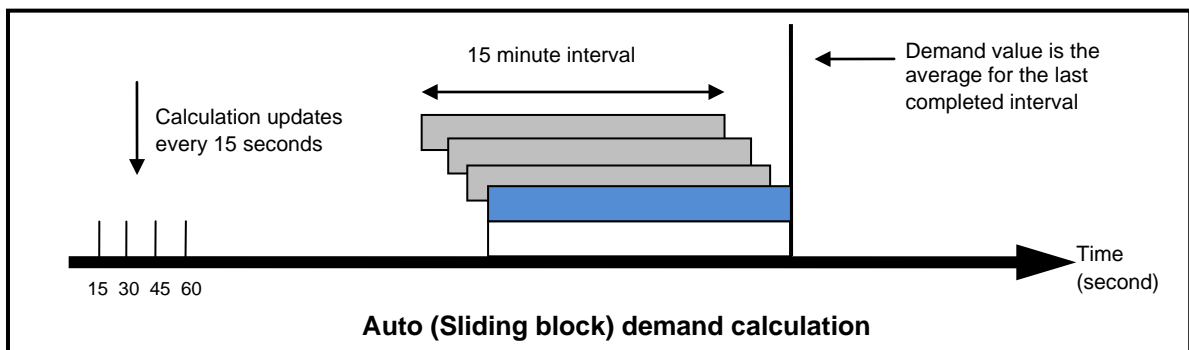

Dual Source Energy Meters Menu Hierarchy

Menu Hierarchy

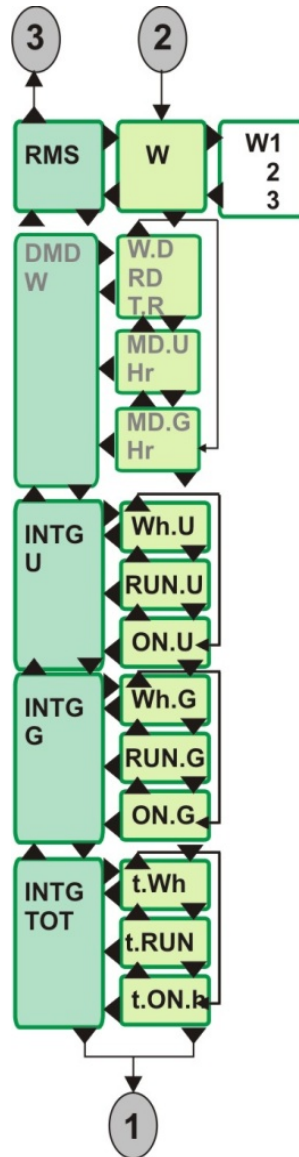

RMS = RMS value display pages are in sub-level

W = Watts, total

W1 = Watts, phase 1
W2 = Watts, phase 2
W3 = Watts, phase 3

DMD W = W Demand; This can be DM A or DM VA depending on the parameter selected in the PROG menu setup.

W.D = W demand
Rd = Rising demand
T.R = Time remaining

MD.U = Maximum demand U
Hr = On hours at which maximum demand has occurred

MD.G = Maximum demand G
Hr = On hours at which maximum demand has occurred

INTG U = Integrator U

Wh.U = Watts hours U

RUN.U = Run hours U

ON.U = On hours U

INTG G = Integrator G

Wh.G = Watts hours G

RUN.G = Run hours G

ON.G = On hours G

INTG TOT = Integrator total, U + G

t.Wh = Total Watts hours U + G

t.RUN = Total Run hours U + G

t.ON = Total On hours U + G

NOTE: **DMD W** display page is available only for EM6438 dual energy meter with demand option.

Menu Hierarchy (Continued)

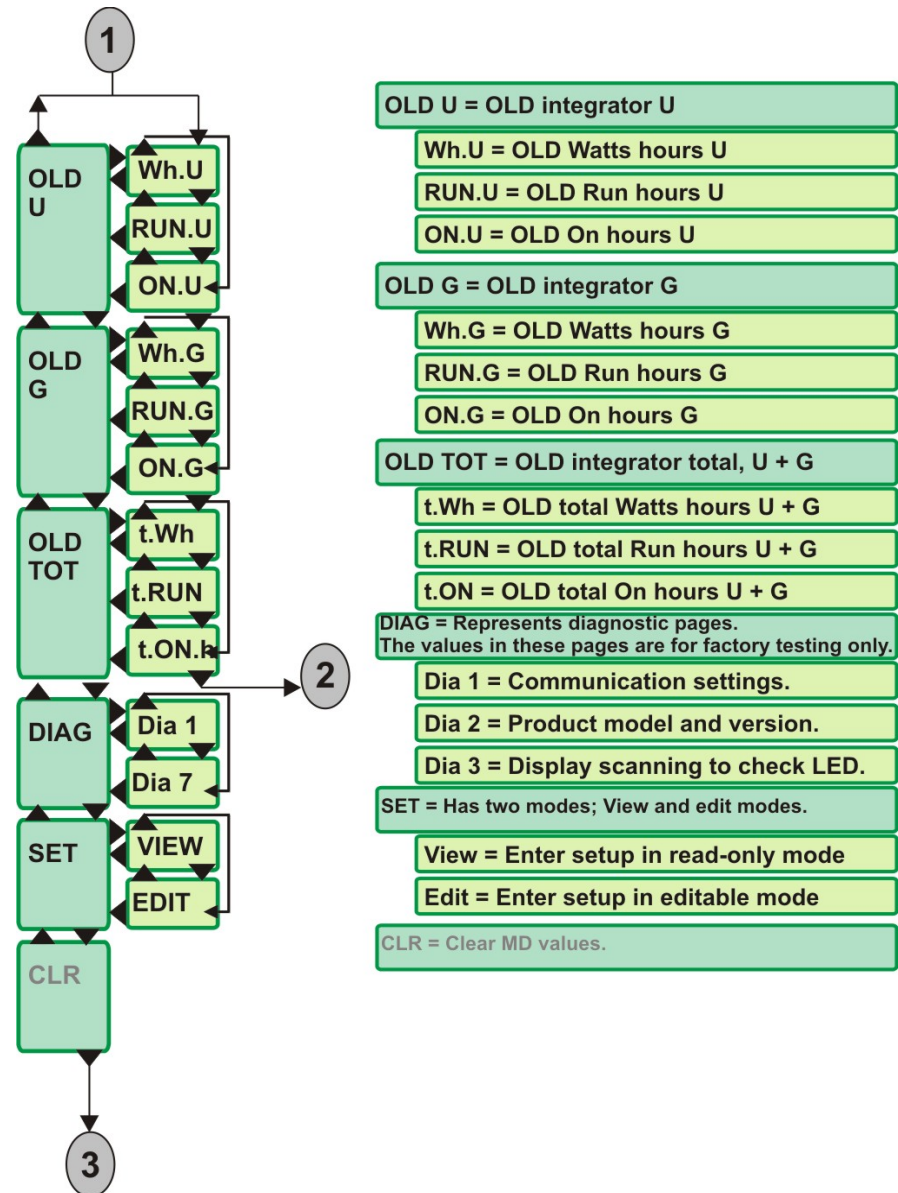

NOTE: CLR display page is available only for the EM6438 dual energy meter with demand option.

Menu Hierarchy (Continued)

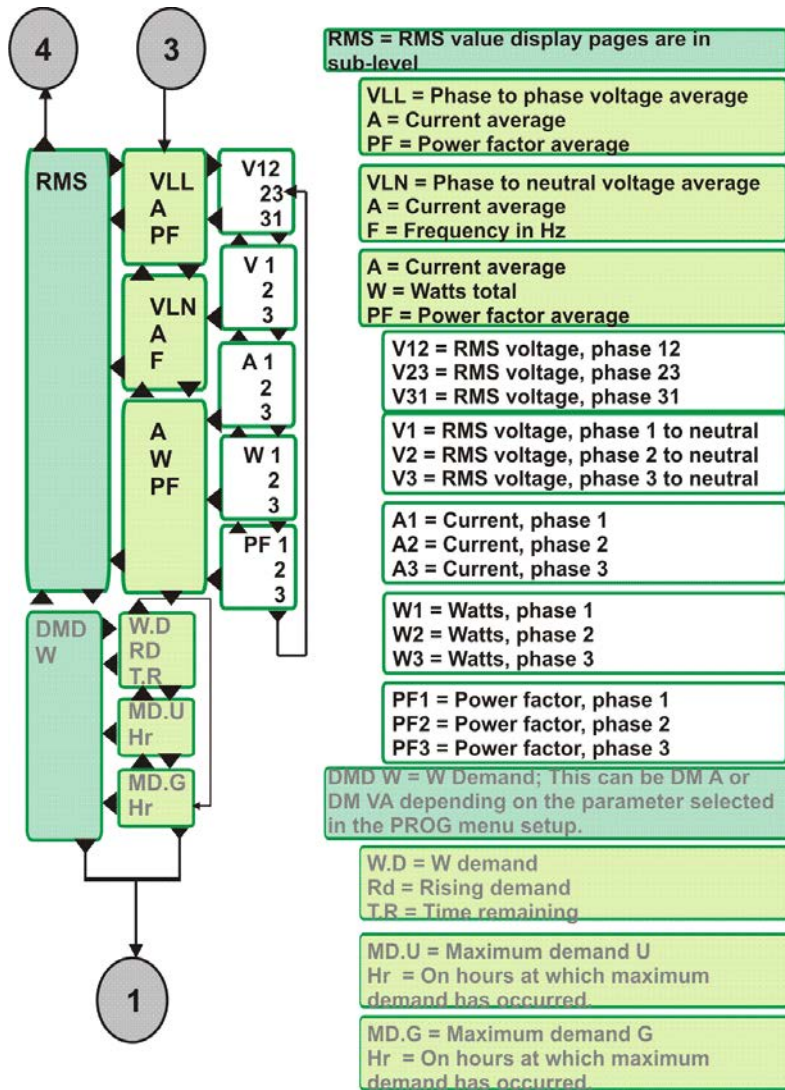

NOTE: DMD W display page is available only with EM6436dual dual energy meter with demand option.

Menu Hierarchy (Continued)

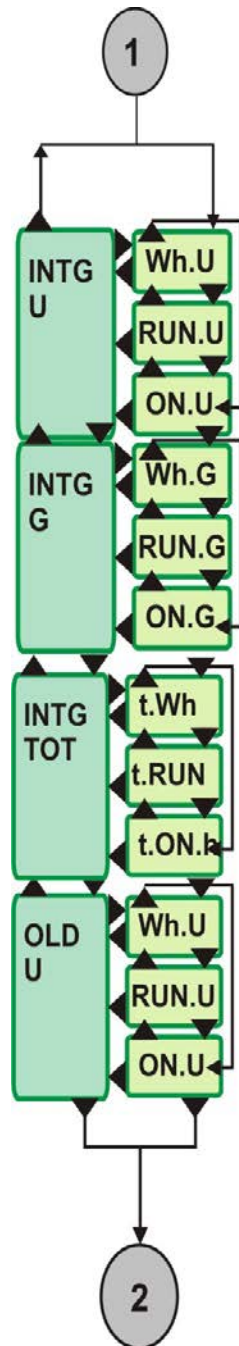

- INTG U = Integrator U
- Wh.U = Watts hours U
- RUN.U = Run hours U
- ON.U = On hours U
- INTG G = Integrator G
- Wh.G = Watts hours G
- RUN.G = Run hours G
- ON.G = On hours G
- INTG TOT = Integrator total, U + G
- t.Wh = Total Watts hours U + G
- t.RUN = Total Run hours U + G
- t.ON = Total On hours U + G
- OLD U = OLD integrator U
- Wh.U = OLD Watts hours U
- RUN.U = OLD Run hours U
- ON.U = OLD On hours U

Menu Hierarchy (Continued)

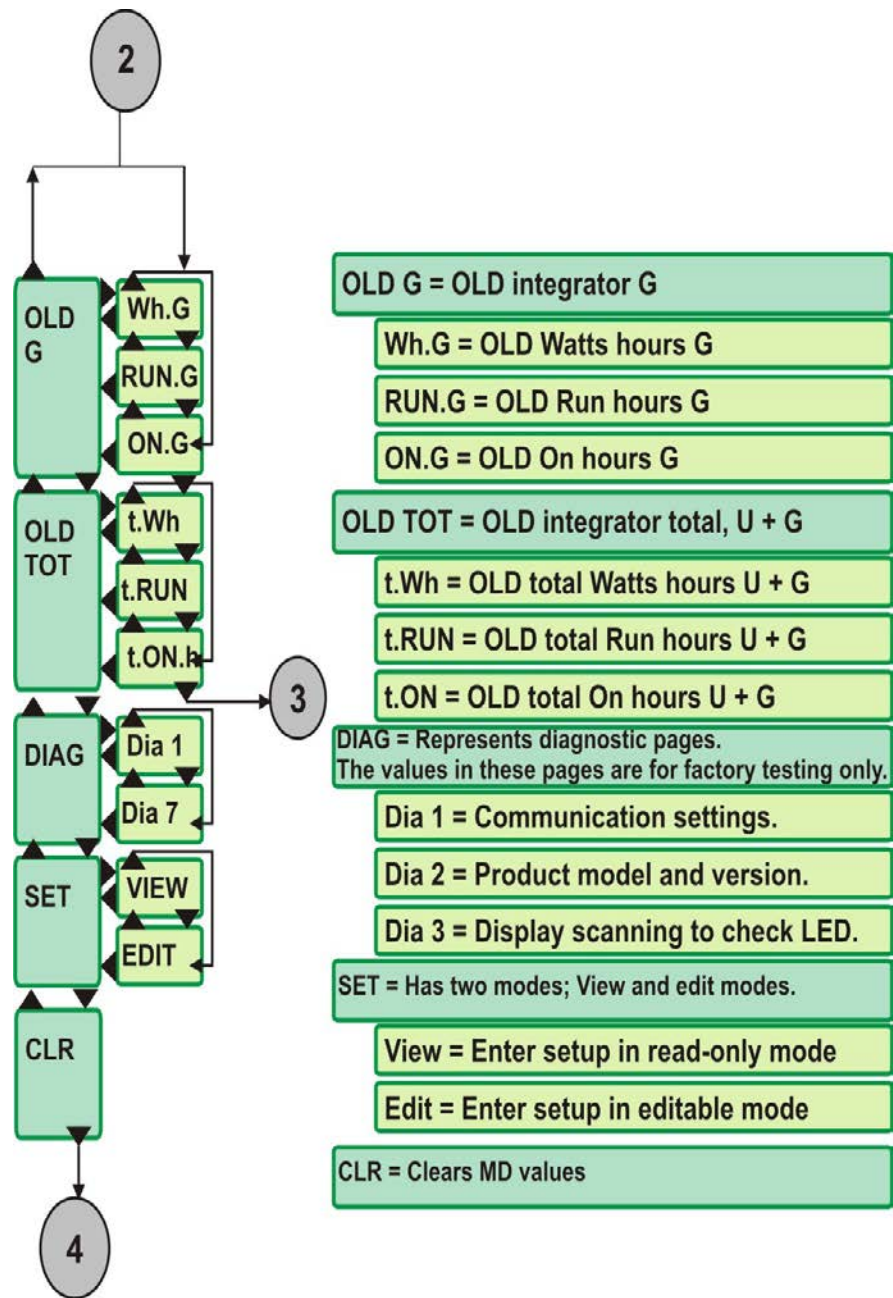

NOTE: CLR display page is applicable only for EM6436dual dual energy meter with demand option.

Chapter 4: AC Power Measurement

3-Phase Systems

A 3-phase system delivers higher levels of power for industrial and commercial applications. The three phases correspond to three potential lines. A 120° phase shift exists between the three potential lines. A typical configuration has either a Delta connection or a Wye (Star) connection

In a 3-phase system, the voltage levels between the phases and the neutral are ideally defined by $V1 = V2 = V3 = V12 / \sqrt{3} = V23 / \sqrt{3} = V31 / \sqrt{3}$. In practice, there will be some unbalance (difference).

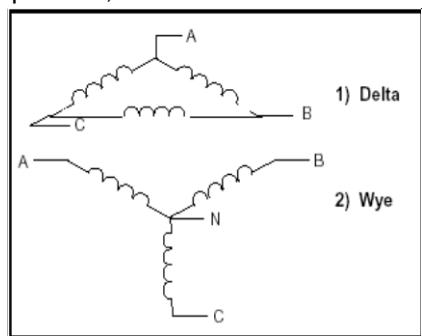

Voltages between the phases vary, depending on loading factors and the quality of distribution transformers.

Power measurement in a poly-phase system is governed by Blondel's Theorem. Blondel's Theorem states that, in a power distribution network, which has N conductors, the number of measurement elements required to determine power is N-1. A typical configuration of a poly-phase system has either a Delta connection or a Wye (Star) connection (see Figure below).

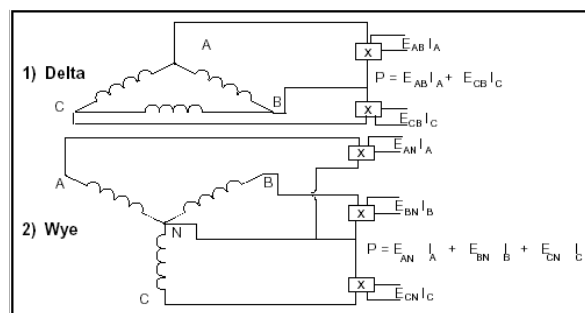

- Where E_{AB} = Voltage across points A and B
- E_{CB} = Voltage across points C and B
- E_{AN} = Voltage across points A and N (Neutral)
- E_{BN} = Voltage across points B and N (Neutral)
- E_{CN} = Voltage across points C and N (Neutral)
- I_A = Current through conductor A
- I_B = Current through conductor B
- I_C = Current through conductor C

Consumption and Poor Power Factor

Consumption: $Wh = W \times T$, where W = instantaneous power, T = time in hours.

The total electric energy usage over a time period is the consumption of Wh . Typically, the unit in which consumption is specified is the kilowatt-hour (kWh): one thousand watts consumed over one hour. Utilities use the Wh equation to determine the overall consumption in a billing period.

Poor power factor: Results in reactive power consumption. Transferring reactive power over a distribution network causes energy loss. To force consumers to correct their power factor, utilities monitor reactive power consumption and penalize the user for poor power factor.

“3D” kVA Measurement

The dual energy meters are equipped with 3D Measurement of kVA. This advanced method provides the most accurate and predictable measurement under unbalanced as well as distorted waveform conditions.

However, in case the dual energy meters need to match the reading of older or simpler dual energy meters, which use the Arithmetic kVA definition, this too is available as a Setup option.

Table 4-1: “3D” kVA Measurement

kVA Function	Formula	Other Names	Which one?
3D Factory setting	$kVA_{3D} = \sqrt{\sum W^2 + \sum VAR^2 + \sum D^2}$ Where D = Distortion Power per IEEE 100	U, Apparent, Vector kVA	Best, all around
Arth	$kVA_{Arth} = kVA_1 + kVA_2 + kVA_3$	Arithmetic, Scalar kVA	Good under Low unbalance, to match simpler meters without 3D capability

Chapter 5: Installation

Mechanical Installation

The dual source energy meters are panel-mounted and have reliable, rear-mounted terminal strips rated at 600 V.

The 92 x 92 mm (3.62 x 3.62 in.) cut-out and 96 x 96 mm (3.78 x 3.78 in.) bezel dimensions adhere to IEC 61554 and DIN 43700.

The diagram below displays the various dimensions of mechanical installations.

Figure 5-1: Mechanical dimensions and recommended panel cut-out

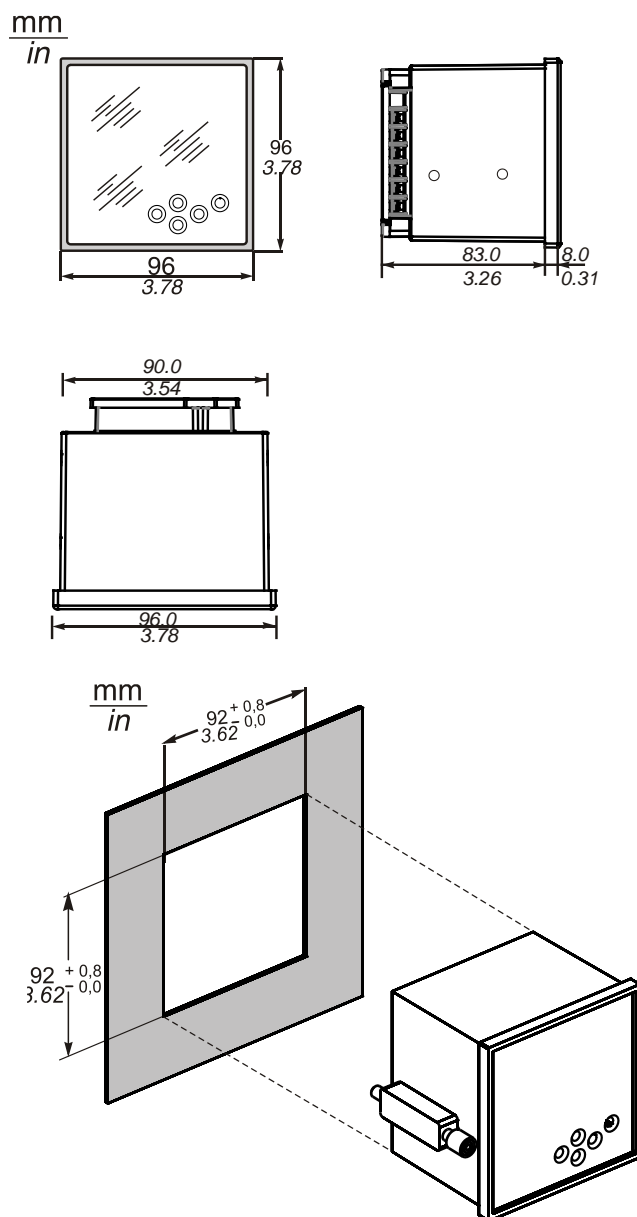

Installation Procedure

Usage

First, decide how the dual energy meter is to be used. If you do not already have an energy management program in operation, then your energy consultant should be able to help you identify which load(s) offer maximum savings potential. This will help you decide which point is to be monitored, from where the readings will be viewed, who must have access to the instrument and how often. Otherwise, decide the location of the dual energy meter and install it. For best performance, choose a location that provides all the required signals with minimum wiring lengths.

Panel Considerations and Environment

The dual energy meter is high-precision measuring instrument, and its operating environment is of utmost importance. For maximum performance, the instrument should be mounted in a dry, dust-free location, away from heat sources and strong electromagnetic fields. To operate reliably, the following conditions must be met:

Table 5-1: Environmental Conditions

Description	Specification
Storage temperature	-25 °C to 70 °C, (-13 °F to 158 °F)
Operating temperature	-10 °C to 60 °C, (14 °F to 140 °F)
Relative humidity	5% to 95%, non-condensing
Altitude	≤ 2000

The dual energy meters should be separated from other equipment and sufficient space must be provided all around for cooling air to rise vertically past the instrument. The cooling air temperature must be below the specified operating temperature.

The panel or housing, in which the dual energy meter is mounted, should protect it from dust, moisture, oil, corrosive vapors, etc.

The panel doors must be easily opened to provide easy access to the dual energy meter wiring for troubleshooting. Allow clearance if the unit is going to swing out, as well as adequate slack in the wiring. Allow space for terminal blocks, CT shorting blocks, fuses, auxiliary contactors, and other necessary components.

Viewing

For ease of operation, the location should be preferably at, or slightly above, eye-level. For viewing comfort, minimize glare and reflections from strong light sources.

Mounting

The dual energy meters are panel mountable.

Table 5-2: Mounting

Description	Specification
Panel cut-out	92 ^{+0.5} ₋₀ mm (w) x 92 ^{+0.5} ₋₀ mm(h) IEC 61554 and DIN 43700
Panel thickness	0.5 to 4.0 mm
Instrumental bezel dimension	96 x 96 mm
Depth behind bezel	83 mm
Mounting clamps screws	Two in numbers, Slotted
Terminal screws	Combination Phillips and slotted head

The cut-out should be punched with the proper tool and should be free from burrs. The following figure explains the mounting of the dual energy meter.

Figure 5-2: Mounting

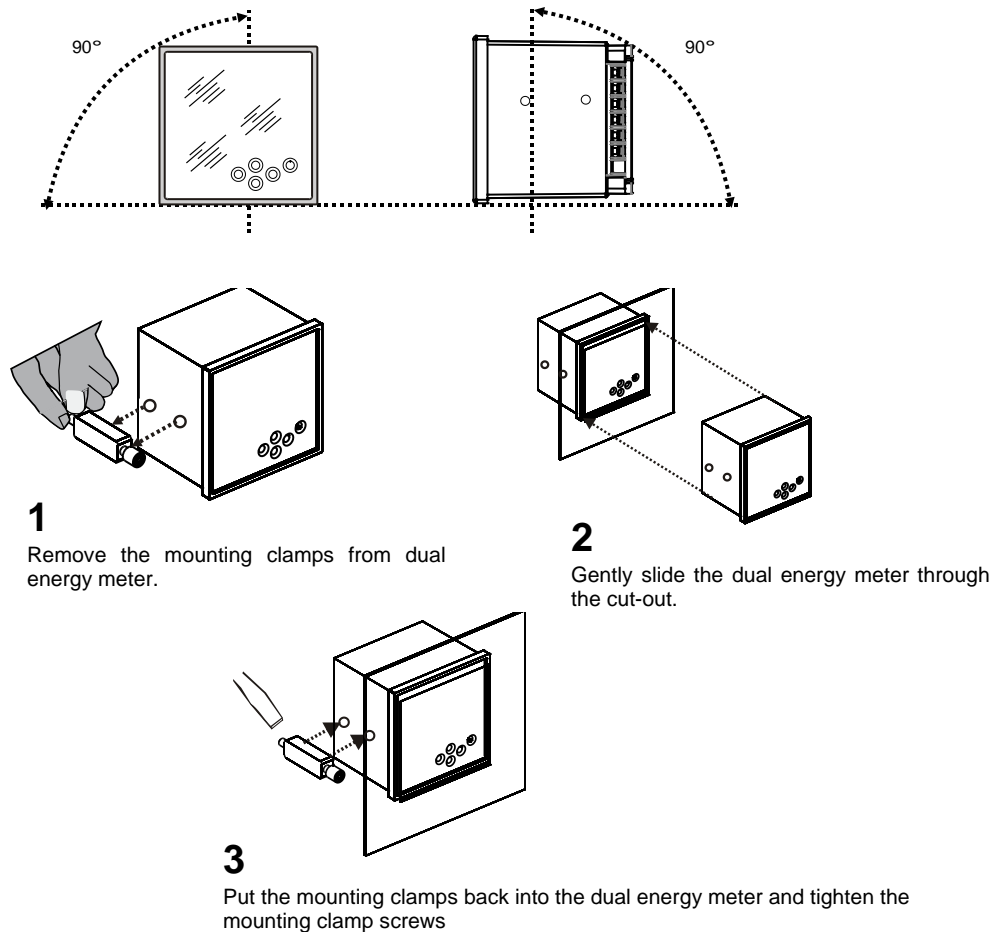

While supporting the dual energy meter from the front, tighten both side clamp screws in a criss-cross pattern until all slack is taken up and then apply one full turn. Do not over-tighten. Over-tightening could result in breaking of the clamps.

The dual energy meter should be separated from other equipment and sufficient space must be provided all around the dual energy meter, to allow air to rise vertically around the dual energy meter. Lack of sufficient air for cooling may result in over heating of the dual energy meter.

NOTE: It is much easier to set up the dual energy meter before you mount the dual energy meter on the panel. See “Quick setup” on page 19 for more information.

Electrical Installation

This section describes the following:

- The need for, and selection of, potential transformers (PTs) and current transformers (CTs).
- Auxiliary supply (control power), PT (VT), and CT connections.

NOTICE

DAMAGE TO THE DEVICE

- Use only the specified tool for tightening and loosening the screw
- Do not over-torque the screw above the specified range

Failure to follow these instructions can result in equipment damage.

For best results, ensure the following specifications:

- Torque driver preferred, hand screwdriver OK.
- TIP: Phillips head is preferred, but flat head is acceptable. Do not use Pozidriv tips.

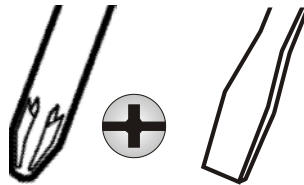

Screw head diameter = 3.5 mm (0.14 in.), TIP shaft diameter < 5 mm (0.2 in.).

IMPORTANT: Screwdriver shafts inserted angularly or of diameter \geq 5 mm (0.2 in.) will get stuck in the cover.

Tightening Torque: 0.25 to 1 N.m (2.21 to 8.85 lb-in)

NOTE: If the torque is more than 1 N.m (8.85 lb-in), then it may damage the screw or the screw head.

Loosening Torque: 1.2 N.m (10.62 lb-in)

Connecting Cable Recommendations

Table 5-3: Connecting cable

	Wire size	Current Rating	Insulation Rating	Temperature rating
Voltage Circuit	1.5 - 2.5 mm ² (16 - 14 AWG)	> 0.1 A	> 600 VAC	> 75 °C (167 °F)
Current Circuit	1.5 - 2.5 mm ² (16 - 14 AWG)	> 7.5 A		

NOTE: Installations should include a disconnecting device, like a switch or circuit breaker, with clear ON/OFF markings to turn-off the auxiliary supply (control power). The disconnecting device should be placed within the reach of the equipment and the operator.

Terminal connections using lugs

Terminal connection using U lugs

Lug type: Insulated sleeved U lugs

Cross-section: 1.5 - 2.5 mm² (16 - 14 AWG)

It is very simple and easy to connect the terminals using the U lugs. The following steps explain how to connect the dual energy meter terminals using U lugs.

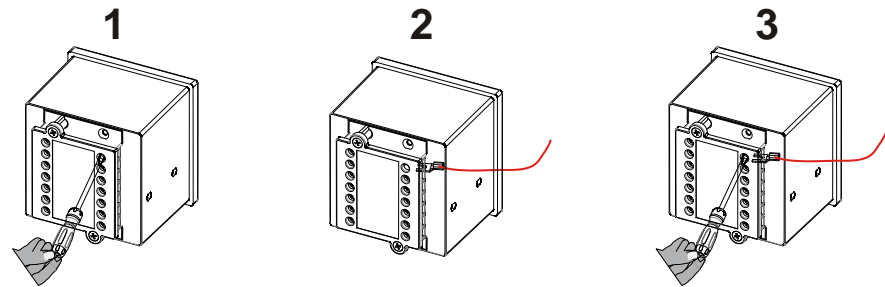

1. Loosen the terminal screw.
2. Connect the wire with the U lug to the dual energy meter terminal.
3. Tighten the terminal screw.

Terminal connections using ring lugs

Lug type: Ring lugs

Cross-section: 1.5 - 2.5 mm² (16 - 14 AWG)

To connect the terminals using ring lugs, follow the steps explained below.

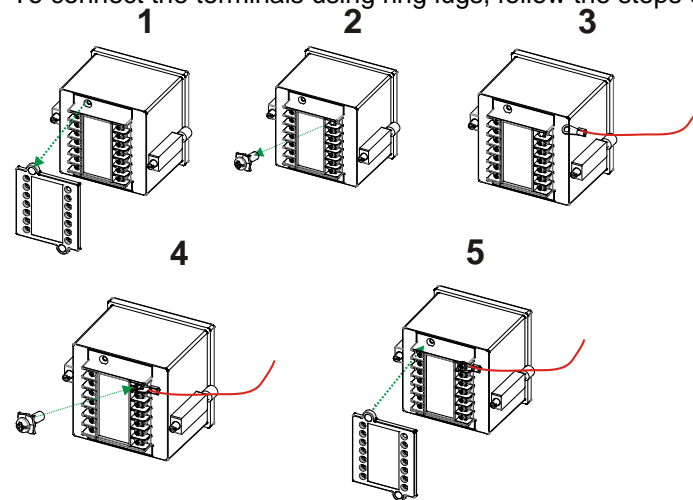

1. Remove the protective cover from the dual energy meter.
2. Remove the terminal screw from the dual energy meter.
3. Connect the wire with the ring lug to the dual energy meter terminal.
4. Place the terminal screw back in the terminal and tighten the terminal screw.
5. Place the protective cover back and tighten the protective cover.

NOTE:

- The above example explains connection for only one terminal. In order to connect the other terminals, repeat the steps 2 and 3 for as many numbers of terminals. Then proceed to the remaining steps.
- To Disassemble the meter, refer to "To Disassemble" on page 73.

Auxiliary Supply (Control Power)

The dual energy meter requires a single-phase AC/DC auxiliary (control) power supply to power its internal electronic circuitry. External surge suppressors are necessary in the auxiliary supply circuit for proper operation during extreme surge conditions, where the voltage surges exceed the auxiliary supply limits (for example, rural areas and outlying areas prone to lightning strikes).

Range:

- 44 to 300 VAC/DC.
- Burden (load) < 3 VA at 240 V AC
< 2 VA at 300 V DC
- The control power may be derived from the voltage signals (≤ 300).
- If you have a 440 V 3-wire delta system and a reliable neutral is not available, use a 440 V: 240 V supply transformer to provide the standard 240 V auxiliary supply.

NOTE: It is much easier to set up the dual energy meter before you mount the dual energy meter on the panel. See "Quick setup" on page 19 for more information.

PTs (VTs) and CTs

Large electrical installations have high voltages and currents, which may exceed the direct connection rating of the dual energy meter. In this case, potential transformers (PTs) and current transformers (CTs) are used to precisely **step down** or reduce the voltage and current levels to suit the dual energy meter rating. Potential transformers usually have a full scale output of 110 VAC RMS line-line and current transformers usually have a full scale output of 5 A or sometimes 1 A.

The PTs (VTs) and CTs must be planned, installed, and tested by a qualified electrical contractor before wiring the dual energy meter. The accuracy of the measurement also depends on the accuracy and phase angle error of the PTs (VTs) and CTs. Instrument class 1 or better PTs and CTs are recommended. Do not use protection class (10P10, etc.) CTs to feed the dual energy meters; they have poor accuracy and phase characteristics. Ensure that the CT Primary rating has been selected so that your normal load variation lies between 40% and 80% of its full scale. If your CT is over-rated, e.g., if the load is always less than 10% of the CT primary rating, then the accuracy suffers. On the other hand, if the CT is underrated, then you may exceed its full-scale. As a result, both the CT and the dual energy meter will burn out.

PT (VT), CT Wiring

The PTs (VTs) and CTs must have adequate VA rating to support the burden (loading) on the secondaries. You may want to support the auxiliary supply burden from one of the PTs (VTs). CT wiring can impose additional burden (loading) on the CT. For example, if the CT has a 5 A secondary and the wire resistance is 1.0 Ω , then the CT has to support an additional burden of 5 VA. If the wiring distance from the CT secondary is greater than stated in Table 5-5 on page 41, then the CT could get over-burdened and give large errors. Choosing a 1 A CT secondary can reduce this error. The CT secondary value must be user programmed into the dual energy meter.

The dual energy meters should be conveniently located for easy connections of voltage (PT), current (CT) signals, and auxiliary (control) supply.

NOTE: The dual energy meters user programmable PT and CT primary or secondary settings may be utilized to Calibrate out the PT and CT amplitude error, for improved accuracy.

Voltage Signal Connections

For proper dual energy meter operation, the voltage connection must be maintained. The voltage must correspond to the correct terminal. The cable required to terminate the voltage sense circuit should have an insulation rating greater than 600 VAC and a current rating greater than 0.1 A. There are four input voltage terminals marked V1, V2, V3, and VN. See the connection diagrams that follow, for details. For Delta connection, the VN terminal should be left unconnected.

PT Connections

The dual energy meters directly accept LV voltage inputs of up to 600 VAC RMS line to line (347 VLN). Voltages greater than this, typically HV systems, must be connected through Potential transformers (PTs). The dual energy meters allow user programming of both PT primary and secondary voltages.

- User programmable PT primary range: 0.1 to 999 kVAC RMS LL
- User programmable PT secondary range: 80 to 601 VAC RMS LL
- Dual energy meter voltage Input burden: < 0.2 VA per input

NOTE: The PT primary and secondary values must be user programmed before using the dual energy meter. Otherwise, the readings will be incorrect.

Selecting the voltage fuses

We strongly recommend using fuses on each of the sense voltages (except for neutral) and the control / auxiliary power.

Table 5-4: Fuse recommendation

Power Source	Source voltage	Fuse
Line voltage	80 to 600 VLL	250mA, 600V AC, fast-acting type
Auxiliary supply (Control power)	44 to 300 VAC/DC	250mA, 300V AC/DC, fast-acting type

Current Signal Connections

The dual energy meter accepts up to 6 A AC RMS per channel directly. Above that, a current transformer must be interposed to scale down the current.

There are three pairs of current input terminals marked A1, A2, and A3. Each pair of input terminals is labeled as S1, S2 and has an arrow indicating the direction of current flow. For proper measurements, the phase identification, and the polarity of the current signals must be correct. The forward flow (import by consumer) current direction must be into the S1 terminal and the exit from the S2 terminal. Maintain the correct sequence and polarity to avoid incorrect readings.

Any unused current input terminals must be shorted together, e.g., in Delta connection, the terminals A2 (S1, S2) must be shorted together. The shorted terminals do not need to be grounded.

The wiring used for the current inputs should have an insulation rating

greater than 600 VAC. The cable connection should be rated for 7.5 A or greater and have a cross-sectional area of 1.5 - 2.5 mm² (16 - 14 AWG) minimum.

CT Connections

Mount the current transformers (CTs) as close as possible to the dual energy meter for best accuracy. The following table illustrates the maximum recommended distances for various CT sizes, assuming the connection is via 1.5 - 2.5 mm² (16 - 14 AWG) cable.

Table: 5-5: CT size and maximum distance

5 A CT size	Maximum Distance in metres (in feet/inch) (CT to dual energy meter)
2.5 VA	3.05 m (10 ft/120 in.)
5.0 VA	4.6 m (15 ft/181 in.)
7.5 VA	9.15 m (30 ft/360 in.)
10.0 VA	12.2 m (40 ft/480 in.)
15.0 VA	18.3 m (60 ft/720 in.)
30.0 VA	36.6 m (120 ft/1441 in.)

- User programmable CT primary range: 1 A to 99 kA AC.
- User programmable CT secondary: 1 A or 5 A AC.
Other values are also programmable to compensate CT errors if desired.
- Dual energy meters CT burden: 0.2 VA maximum per input.

See “PROG menu — Setup” on page 19 for more information.

NOTE:

The PT primary and secondary values must be user programmed before using the dual energy meter. Otherwise, the readings will be incorrect.

With dual- range CTs; select the best range for programming the dual energy meter. If you change the range thereafter without re-programming the dual energy meter, the dual energy meter will read erroneous values.

CT Polarity

When the dual energy meter is connected using the CTs, you must maintain correct CT polarities. CT polarities are dependent upon correct connections of CT leads, and upon the direction the CTs are facing when clamped around conductors. The dot on the CT must face the line side; the corresponding secondary connection must connect to the appropriate input on the dual energy meter.

Failure to connect CTs properly results in inaccurate power readings. If your dual energy meter is not reading power properly, it is most likely that the CT is incorrectly wired. If one or two CTs are reversed, then energy parameters accumulate only one phase value. If two or all the phases of the CT are reversed, energy will not accumulate. (Energy import will not be measured).

CT Connection Reversal

To check the polarity of the CT after the dual energy meter has been installed, simply look at the phase-wise W (Watt) readings to see that each of the readings are positive (assuming you are consuming power). If one of the W readings is negative, that particular phase CT is reversed and must be corrected. On the other hand, if you are exporting power, all three phase-wise W readings must be negative.

Setup — System Type

The dual energy meter needs to know the type of system to which it is connected to. This information is programmed in the setup procedure, before using the dual energy meter. The dual energy meter does allow you to change this setting while it is running; however, this capability is meant for correcting a gross error, or for training or educational purposes; it is not to be changed on regular basis. The options are:

- **Wye/Star:** For 3-phase 4-wire, **three Watt-meter** or **three Element** circuits. Here, all three voltage phase signals, the neutral voltage connection, and all three current input signals need to be wired in. This means all the four voltage terminals, and six current terminals described in the following section, need to be wired. For wye/star wiring configuration, see “3-phase 4-wire WYE connection with 3 CTs and 3 PTs” on page 46 for more information.
- **Delta:** For 3-phase 3-wire, **two Watt-meter** or **two Element** circuits. For delta and open delta wiring configuration, see “3-phase 3-wire Delta connection with 2 CTs and 3 PTs” and “3-Phase 3-Wire Open Delta connection with 2 CTs and 2 PTs” on page 47 for more information.
- **2-phase:** For 2-phase 3-wire, **two Watt-meter** or **two Element** circuits. Here, the two voltage phase signals, the neutral voltage connection, and two current input signals need to be wired in. This means that the three voltage terminals and four current terminals described in the following section, need to be wired. For two phase wiring configuration, see “2-phase 3-wire connection with 2 CTs” on page 48 for more information.
- **Single-phase:** For single-phase 2-wire, **one Watt-meter** or **one Element** circuits. Here a single voltage Phase signal, the neutral voltage connection, and a single current input signal need to be wired in. This means that two voltage terminals and one current terminal described in the following section need to be wired. For Single phase wiring configuration, see “Single phase connection with 1 CT” on page 48 for more information.

Phase Labels



The phase labels shown on the display are programmable via the dual energy meters front panel PROG menu. You can setup the meter to display phase labels convenient to your practice. The choices available are: 123 (factory set), RYB, RST, PQR, ABC.

Connection Diagrams

Choose the diagram below that best describes your application. You must ensure that the CT phase and corresponding PT phase are identical and that the CT polarity is correct. Follow the outlined procedure to verify correct connection.

Connection Diagram Symbols

Table 5-6: Connection diagrams symbols

Symbol	Description
	Fuse
	Current transformer

3-phase 4-wire WYE connection

Direct voltage connection for the input voltages L-L up to 600 VAC.
Otherwise use three PTs.

Figure 5-3: 3-phase 4-wire WYE connection

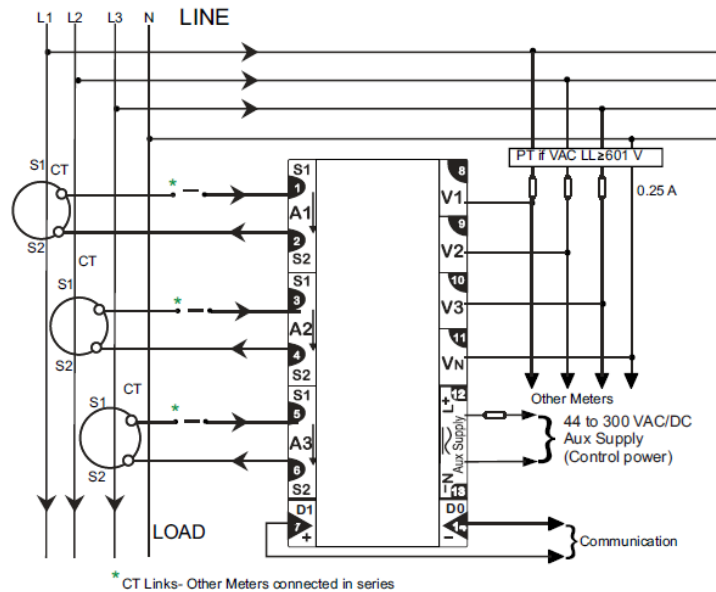

NOTE:

Make sure WYE/Star is programmed in the dual energy meter PROG menu- Setup.

For High – leg (US connection)

L1 – N = 120 V

L2 – N = 208 V

L3 – N = 120 V

3-phase 3-wire delta connection

Direct voltage connection for the input voltages L-L up to 600 VAC.
Otherwise use three PTs

Figure 5-4: 3-phase 3-wire delta connection

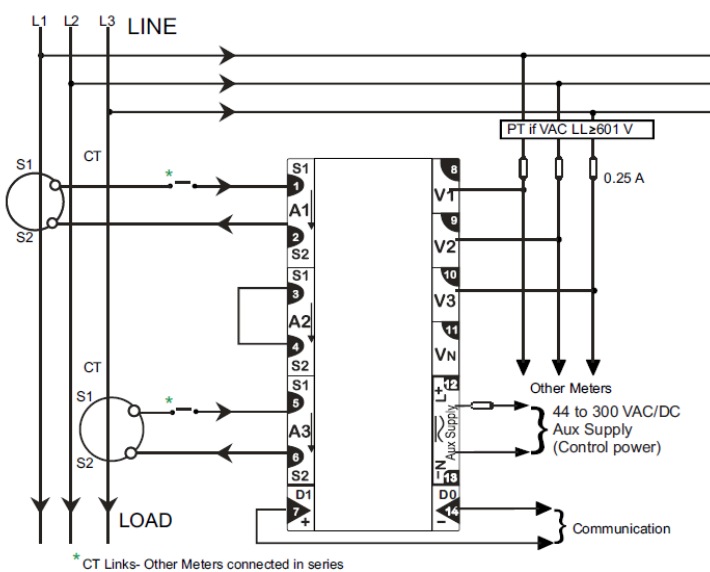

NOTE: Make sure Delta is programmed in the dual energy meter PROG menu- setup. Leave the VN terminal disconnected.

3-phase 3-wire open delta connection

Direct voltage connection for the input voltages L-L up to 600 VAC. Otherwise use two PTs.

Figure 5-5: 3-phase 3-wire open delta connection

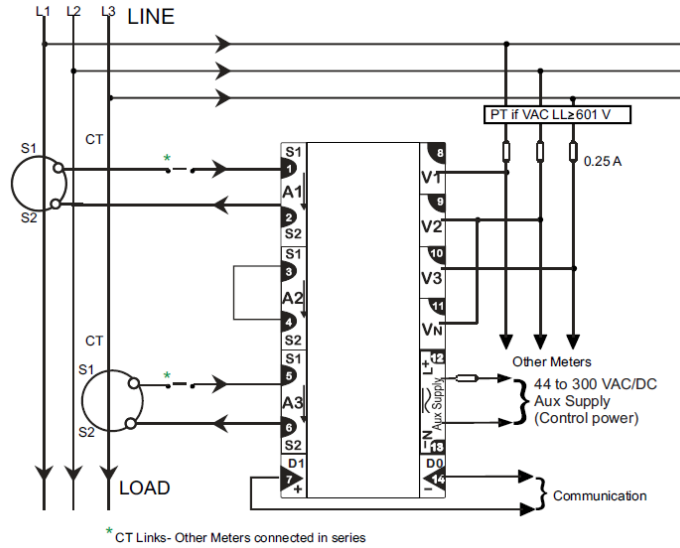

NOTE: Make sure Delta is programmed in the dual energy meter PROG menu-setup.

2-phase 3-wire connection

Direct voltage connection for the input voltages L-L up to 600 VAC. Otherwise use two PTs.

Figure 5-6: 2-phase 3-wire connection

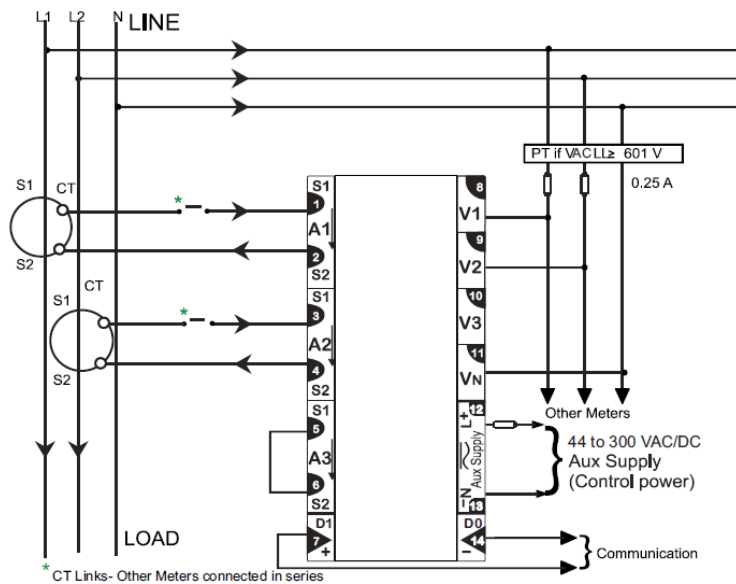

NOTE: Make sure 2-phase is programmed in the dual energy meter PROG menu- setup.

Single-phase connection

Direct voltage connection for the input voltages L-L up to 600 VAC.
Otherwise, use one PT.

1. Program the dual energy meter in single-phase mode.
However, voltages primary and secondary need to be programmed as Line to Line.
2. Connect the voltage and current inputs only to the V1 and A1 voltage and current terminals of the dual energy meter.
3. The unused current terminals (A2 and A3) must be shorted together to reduce noise picked up in the dual energy meter.
4. However, the energy parameter readings will be accurate.

Figure 5-7: Single-phase connection

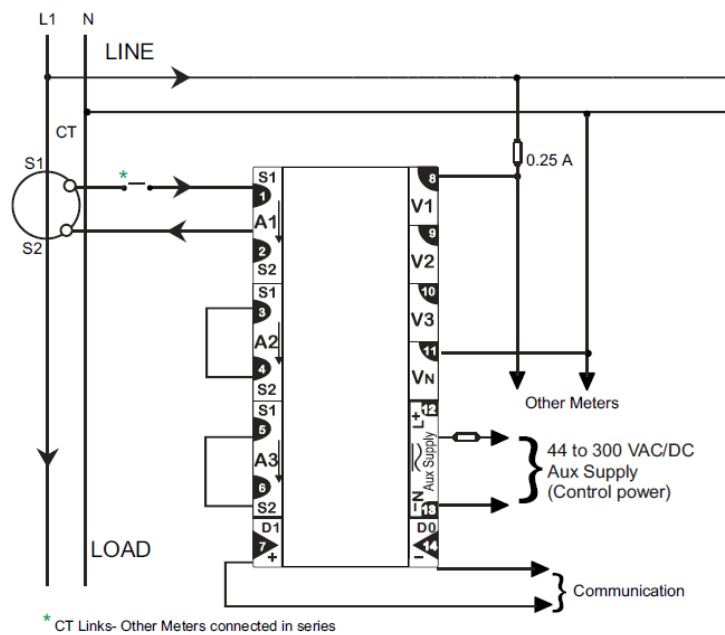

* CT Links- Other Meters connected in series

G Sense Wiring

CAUTION
<p>HAZARD OF EQUIPMENT DAMAGE</p> <p>The connector has to be wired first and mounted only when the dual energy meter is placed in the panel.</p> <p>Failure to follow this instruction will result in equipment damage.</p>

Figure 5-8: G sense wiring

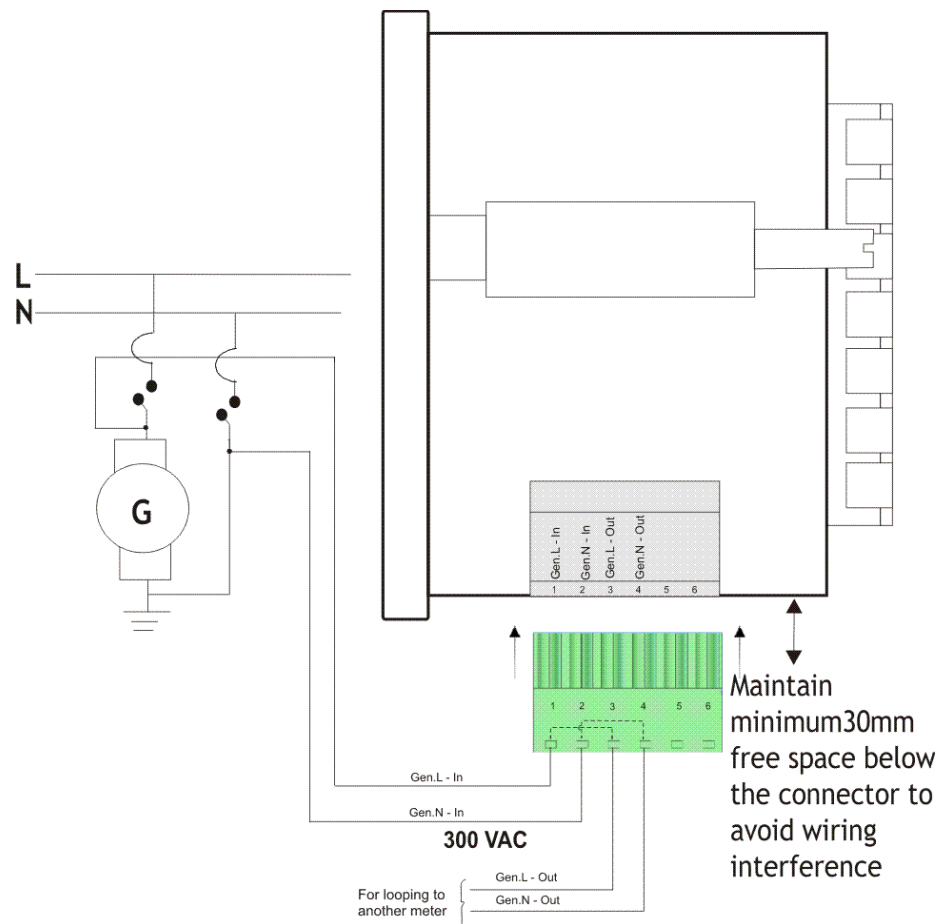

Note:

Wiring recommendation for Connector

- For Single Wire: The maximum permissible cross-section is 2.5 mm².
- For Two Wires: The maximum permissible cross-section is 1.5 mm²/wire.

Chapter 6: Data Communication

This section is applicable only for dual energy meters with RS 485 communication option.

Float Byte Register

Float Byte Characteristics:

- Block wise access.
- If Read and Write values are matching, then it means the float byte sequence is in sync with the master.
- The float byte number is fixed.

Table 6-1: Float Byte Test Sequence Register

Addr: 320-321 (2 registers)	Data Type	Description	Property
4030201.0	Float	Before starting the communication, you must write this number and read.	Normal Read and Write.

Note:

- If any other write value is given as input other than the mentioned write value in the above table, then the meter will give a data exception response.
- If you do not want the default value, you can always set the desired values in the Edit page.

Health Check Register

Health Check Register Characteristics:

- Normal Read Only.
- 16bit UNIT.
- Identifies the meter existence in the network.

Table 6-2: Health Check Register

Addr: 0304 (1 register)	Data Type	Description	Property
Model Type	UNIT16	To identify the meter presence in the network.	Normal Read.

Float Byte Order Detection

Float Byte Order Detection Characteristics:

- Normal Read Only.
- 16bit UNIT.
- Identifies the float byte order in the meter.

Table 6-3: Float Byte Order Detection

Addr: 0306 (1 register)	Data Type	Description	Property
Model Type	UNIT16	To identify the float byte order in the meter.	Normal Read.

RS 485 Data Port

Data Port Advantages:

- Rapid, on-line, real time readings into
- Your own SCADA software or PLC.
- Schneider Electric energy management software products such as Vijeo Citect, PowerLogic SCADA for pinpointing energy usage and waste.
- It supports ION™ enterprise.
- Data port has built-in impedance matched design for low reflectance on long data cables at high Baud rates. Eliminates need for complicated impedance matching resistors at the ends of long data cables.
- Fast 16 ms dual energy meter response, average time to read 10 parameters is 90 to 100 ms (9600 Baud, Even parity, One stop bit).
- Direct reading, pre-scaled Float readings. Accurate, full precision low, and high readings. No need for additional scaling factors or decimal adjustment.
- Fast, easy-to-use grouping of parameters tuned for field requirements.
- TURBO area for single point polling (upto 50 per query)
- Block area for even faster access to pre-configured data blocks

Installation

Figure 6-1: 2-wire half duplex communication connection

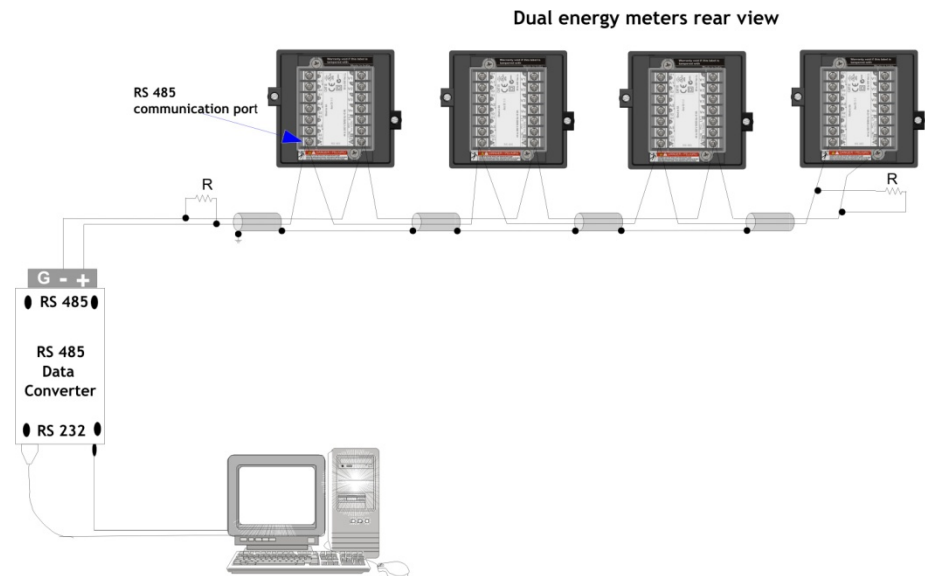
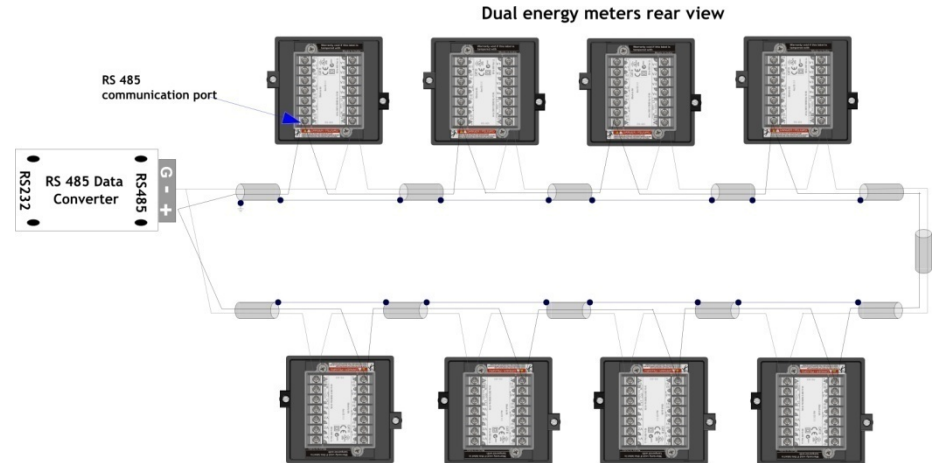

Figure 6-2: Closed loop, 2-wire half duplex.
Advantage – Reliable communications, tolerant to one break in the cable.



Communication Capabilities

Table 6-4: RS 485 communication distances

Baud Rate	Maximum communication distances 1 to 32 devices
	Meters (Typical with Belden 3105A cables)
9600	1200
19200	900

NOTE: Distances listed should be used as guide only and cannot be guaranteed for non-Schneider Electric devices. Above distances subject to vary based on the quality of the cable.

Daisy-chaining Devices to the Dual energy meter

The RS 485 slave port allows the dual energy meter to be connected in a daisy chain with up to 31 2-wire devices. In this bulletin, *communications link* refers to a chain of devices that are connected by a communications cable. See Figure 6-3.

Figure 6-3: Daisy-chaining 2-wire devices

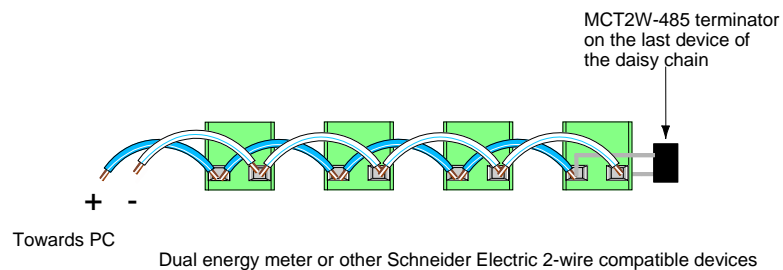

- If the dual energy meter is the first device on the daisy chain, connect it to the host device using a RS 232 to RS 422/RS 485 converter or RS 485 to Ethernet converter.
- If the dual energy meter is the last device on the daisy chain, terminate it with the terminator provided.

- See “Table 6-1” on page 53, for the maximum daisy-chain communications distances for 2-wire devices.
- The terminal’s voltage and current ratings are compliant with the requirements of the EIA RS 485 communications standard.

NOTE: For better performance, Schneider Electric recommend to use SWG 100 % shielded cable with low resistance (Belden or Lapp make).

Data Formats and Settings

Your SCADA software must be configured for Modbus RTU communication, before integrating the Schneider Electric dual energy meter. The mode of transmission is defined in the following which is compatible with Modbus RTU Mode:

Table 6-5: Dual energy meter communication and protocol settings

Dual energy meter communication settings	
Protocol	Modbus RTU
Data bits	8
Baud rate	9600 Baud, User set 4800 to 19200 Range: 4800, 9600, 19200 Normal use: 9600 Baud Noisy, EMI, RFI, long data cable: 4800 Baud Short cable (<300 meters or 975 feet): 19200 Baud
Parity	Even
Device Address	1
Stop bit	1
Modbus Protocol	
Device Address	1 to 247 Upto 247 meters per COM port with repeaters
Function Code	03 (Read)
Data Address	Refer to “Data address” on page 58 for more information
Data type	32-bit float (real) : <ul style="list-style-type: none"> • All parameters. • Direct reading, little-endian float, big-endian float, no scaling required 32-bit unsigned integer • INTR (number of interruptions (outages) - RMS Blocks) • RunSec (Run seconds – Integ Block)
No of Registers	2 to 50 (optional) per dual energy meter data block of 10 x 32 bit values must be configured to suit the dual energy meter

NOTE: The polling interval to poll the data from dual energy meter will depend on baud rate. We recommend polling interval of one second at 9600 Baud rate.

Modbus Standard Device Identification

Addressing the Modbus standard device identification

You can use Modbus command 0x2B/0x0E on these device identification parameters.

Table 6-6: Modbus standard device identification parameters

Object ID	Object Name	Format	Access
00	Manufacturer name	String	R
01	Product code	String	R
02	FW Version	String	R

NOTE:

- The Read device identification can be read as stream access and as individual access.
- The product code is the same file name without version number.

Parameter Settings for Different SCADA Software

The following table explains how to read the parameter VA (See “Individual parameter address” on page 58 for more information) in different Modbus master software/PLC’s.

Table 6-7: Parameter settings

Sl. No	SCADA software	Start Address	Function Code	No. of Register	Data Type	Remarks
1	ION™ Enterprise	43901	Internally configured	2	Swapped Float	Direct conversion
2	PowerLogic SCADA	43901	Internally configured	2	Real	Direct conversion
3	Vijeo Citect	43901	Internally configured	2	Real	Direct conversion
4	Intouch	43901 F	Nil	2	Float	Direct conversion
5	Modscan (Master)	3901	03 – HOLDING REGISTERS	2	Floating point	Unswapped FP mode
6	MODTEST	43901	03 – Rosemount	Points -1	Float-Rosemount	
7	CIMPLICITY	43901	Nil	100	Real	Direct conversion. The array concept can be used here to poll all the data in single scan.
8	Allenbradly – Micrologix PLC (Slave/Master)	43901	03-HOLDING REGISTERS	2	Floating point	Direct
9	GE Fanuc PLC	43901	03-HOLDING REGISTERS	2	Real	Direct
10	ABB RTU 560 (Mater)	Index-3900	03- Read HOLDING REGISTERS	Query Range - 2	MFI – Analog measured Floating value	Under sub parameters, “Sign and Exponent in First Register” should be disabled (Unchecked)
11	SIEMENS PLC (Master)	3900	03-HOLDING REGISTERS	2	Real	Direct
12	MOVICON	43901	Nil	2	Real	Direct
13	RSVIEW	43901	03-HOLDING REGISTERS	2	Real	Direct
14	ABB Microscada	3900	Format – 9	Interval – 2	Real	Direct

Communication Test

Communication test: The dual energy meter can be successfully used for communication using Modscan software as Modbus master in PC. Details of the settings in Modscan are given below.

Settings in Modscan v3.D05-00 software to establish communication with dual energy meters:

- Free download demo Modscan software from <http://www.win-tech.com>.
- The following explains how to read apparent power total (VA total) from register 3901.

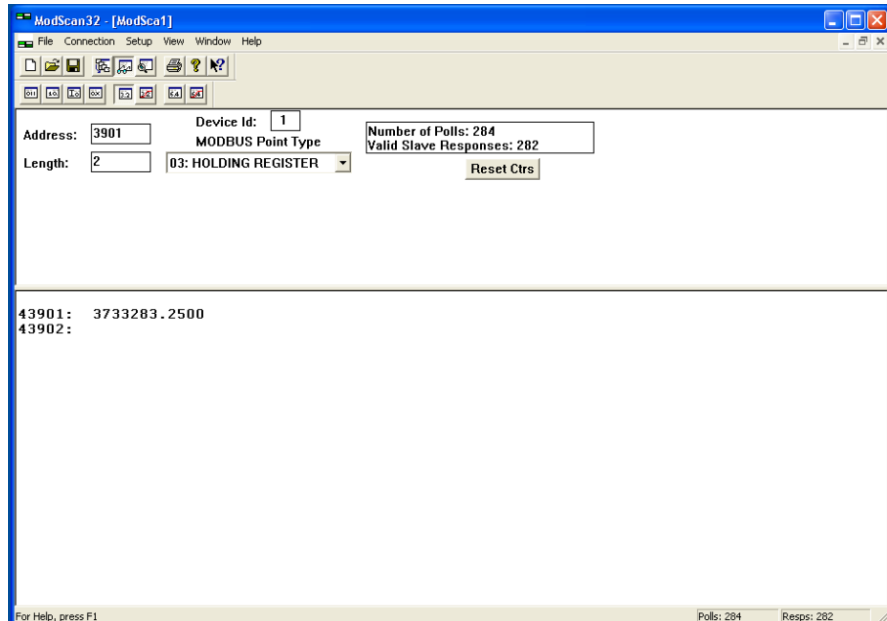

1. After starting the Modscan, to read Apparent power total (VA total), enter address as 3901 (decimal), length as 2, device ID as 1, Modbus point type as 03, and HOLDING REGISTER.
2. **Modify the connection details:** Click connection > connect, to see the **connection detail window**. Change all the settings to match the following screen. These are default settings of the dual energy meter.

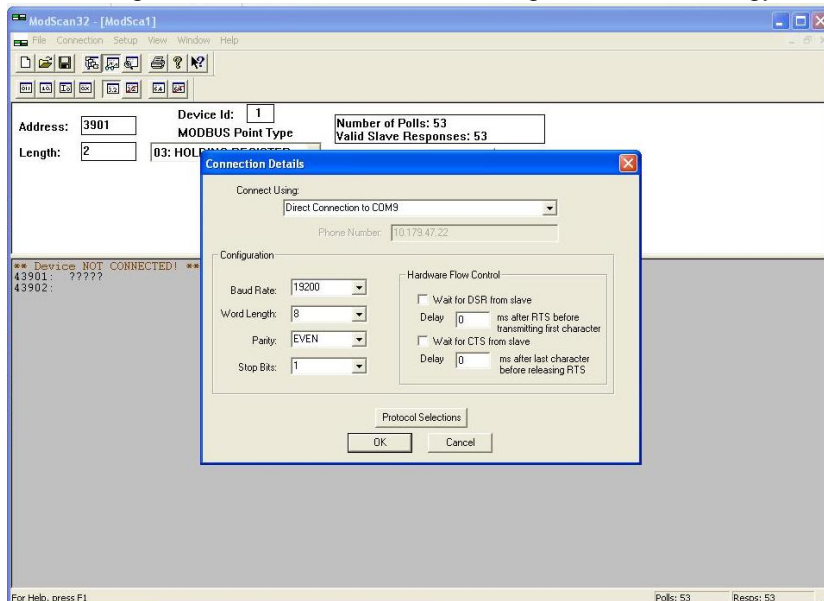

- Set the Modbus protocol selections: On **Connection details** window (shown in previous step), click on **Protocol Selections**. Enter the protocol settings as shown below and click **OK** in all the windows.

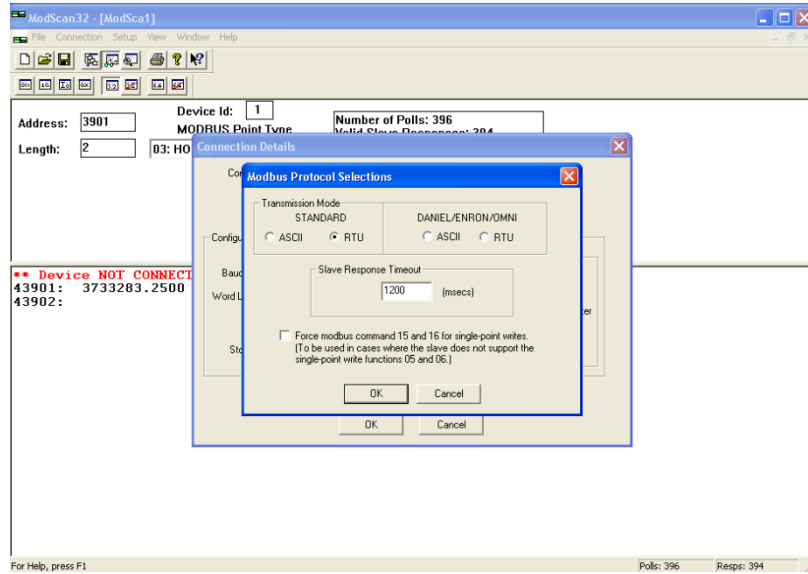

- The Modscan software starts polling the configured COM port for the Device ID 1. Modscan Demo software will stop polling after 3.5 minutes.

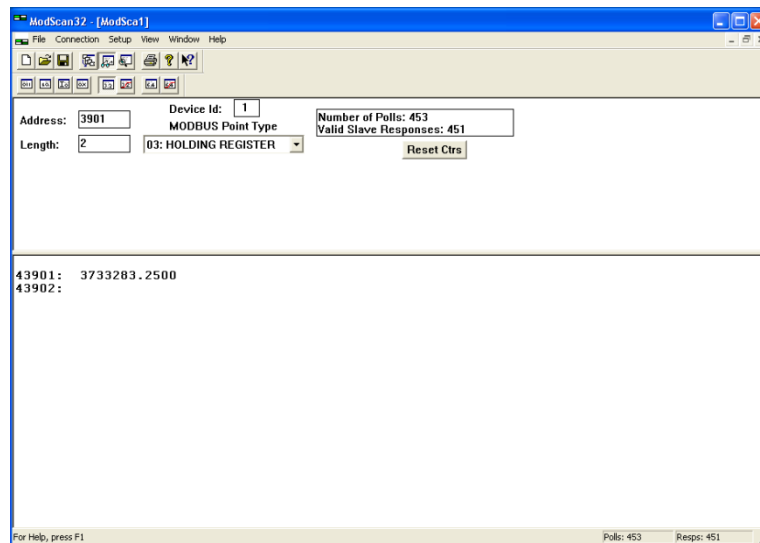

This shows that the dual energy meter is communicating with the Modbus Modscan master software successfully on the PC. The dual energy meter is Modbus RTU compliant.

Data Address

The dual energy meter supports the transfer of whole block and also of individual data values (two registers are used for storing single data values).

- In the transfer of individual data values, it treats two registers as an object with the starting address (e.g., 3900) considered as the object name. This enables you to transfer required data values for energy management.
- In the transfer of the whole block, it basically treats each block as an object

with the starting address (e.g., 3000) considered as the object name. This enables fast block transfers, since energy management usually requires a block of related readings for the same point of time. This method also eliminates time-skew within readings of that block.

- The device address, block start address, number of registers, must be configured to suit the dual energy meter. You must also make the related SCADA settings for polling priority, logging, and viewing the data. Refer your SCADA software instructions to learn how to do this.

Individual Parameter Address:

- Function Code: 03 Read
- No scaling required
- Read as block or individual parameters

Table 6-8: Individual parameter address

Parameter	Description	Address	Type	EM6438	EM6436dual
Metering					
Metering - Current					
A	Current average	3913	Float	-	✓
A1	Current, phase 1	3929	Float	-	✓
A2	Current, phase 2	3943	Float	-	✓
A3	Current, phase 3	3957	Float	-	✓
Metering – Voltage					
VLL	Line to line average voltage	3909	Float	-	✓
VLN	Line to neutral voltage	3911	Float	-	✓
V12	Voltage phase 1 to phase 2	3925	Float	-	✓
V23	Voltage phase 2 to phase 3	3939	Float	-	✓
V31	Voltage phase 3 to phase 1	3953	Float	-	✓
V1	Voltage phase 1 to neutral	3927	Float	-	✓
V2	Voltage phase 2 to neutral	3941	Float	-	✓
V3	Voltage phase 3 to neutral	3955	Float	-	-
Metering – Power					
W	Active power, total	3903	Float	✓	✓
W1	Active power, phase 1	3919	Float	✓	✓
W2	Active power, phase 2	3933	Float	✓	✓
W3	Active power, phase 3	3947	Float	✓	✓
VA	Apparent power, total	3901	Float	✓	✓
VA1	Apparent power, phase 1	3917	Float	✓	✓
VA2	Apparent power, phase 2	3931	Float	✓	✓
VA3	Apparent power, phase 3	3945	Float	✓	✓
Metering – Power Factor					
PF	Power factor average	3907	Float	-	✓
PF1	Power factor, phase 1	3923	Float	-	✓
PF2	Power factor, phase 2	3937	Float	-	✓
PF3	Power factor, phase 3	3951	Float	-	✓
Metering - Frequency					
F	Frequency, Hz	3915	Float	-	✓
Energy					
VAh.U	Apparent energy, utility	3959	Float	✓	✓
Wh.U	Active energy, utility	3961	Float	✓	✓
On.U	On hours, utility	3965	Float	✓	✓
Run.U	Run hours, utility	3995	Long	✓	✓
VAh.G	Apparent energy, generator	3967	Float	✓	✓
Wh.G	Active energy, generator	3969	Float	✓	✓
On.G	On hours, generator	3973	Float	✓	✓
Run.G	Run hours generator	3997	Long	✓	✓
Demand					

Present Demand	Present demand	3975	Float	✓	✓
Rising Demand	Rising demand	3977	Float	✓	✓
Max MD U	Maximum demand, utility	3979	Float	✓	✓
Max DM Occurrence Time U	Maximum demand occurrence time, utility	3981	Long	✓	✓
Percentage of Load parameters					
% Avg Load	Average load percentage	3881	Float	✓	✓
%L1	Percentage of phase 1 load	3883	Float	✓	✓
%L2	Percentage of phase 2 load	3885	Float	✓	✓
%L3	Percentage of phase 3 load	3887	Float	✓	✓
Unbalanced %Load	Unbalanced %load	3889	Float	✓	✓
Unbalanced % voltage	Unbalanced % voltage	3891	Float	✓	✓

Block Parameter Address

Total RMS Block:

- Function Code: 03H Read
- Number of registers: 20
- No scaling required
- Read as block only

Table 6-9: Total RMS block

Parameter	Description	Address	Type	EM 6438	EM 6436dual
VA	Apparent power, total	3001	Float	✓	✓
W	Active power, total	3003	Float	✓	✓
Reserved	Reserved	3005	Float	-	-
PF	Average PF	3007	Float	-	✓
VLL	Average line to line voltage	3009	Float	-	✓
VLN	Average line to neutral voltage	3011	Float	-	✓
A	Average current	3013	Float	-	✓
F	Frequency, Hz	3015	Float	-	✓
Reserved	Reserved	3017	Long	-	-
Reserved	Reserved	3019	Long	-	-

R phase RMS Block:

- Function Code: 03H Read
- Number of registers: 20
- No scaling required
- Read as block only

Table 6-10: R phase RMS block

Parameter	Description	Address	Type	EM 6438	EM 6436dual
VA1	Apparent power, phase1	3031	Float	✓	✓
W1	Active power, phase1	3033	Float	✓	✓
Reserved	Reserved	3035	Float	-	-
PF1	Power factor, phase1	3037	Float	-	✓
V12	Voltage phase1 to phase2	3039	Float	-	✓
V1	Voltage phase1 to neutral	3041	Float	-	✓
A1	Current, phase1	3043	Float	-	✓
F1	Frequency, Hz	3045	Float	-	✓
Reserved	Reserved	3047	Long	-	-
Reserved	Reserved	3049	Long	-	-

Y phase RMS Block:

- Function Code: 03H Read
- Number of registers: 20
- No scaling required
- Read as block only

Table 6-11: Y phase RMS block

Parameter	Description	Address	Type	EM 6438	EM 6436dual
VA2	Apparent power, phase 2	3061	Float	✓	✓
W2	Active power, phase 2	3063	Float	✓	✓
Reserved	Reserved	3065	Float	-	-
PF2	Power factor, phase 2	3067	Float	-	✓
V23	Voltage phase 2 to phase 3	3069	Float	-	✓
V2	Voltage phase 2 to neutral	3071	Float	-	✓
A2	Current, phase 2	3073	Float	-	✓
F2	Frequency, Hz	3075	Float	-	✓
Reserved	Reserved	3077	Long	-	-
Reserved	Reserved	3079	Long	-	-

B phase RMS Block:

- Function Code: 03H Read
- Number of registers: 20
- No scaling required
- Read as block only

Table 6-12: B phase RMS block

Parameter	Description	Address	Type	EM 6438	EM 6436dual
VA3	Apparent power, phase 3	3091	Float	✓	✓
W3	Active power, phase 3	3093	Float	✓	✓
Reserved	Reserved	3095	Float	-	-
PF3	Power factor, phase 3	3097	Float	-	✓
V31	Voltage phase 3 to phase 1	3099	Float	-	✓
V3	Voltage phase 3 to neutral	3101	Float	-	✓
A3	Current, phase 3	3103	Float	-	✓
F3	Frequency, Hz	3105	Float	-	✓
Reserved	Reserved	3107	Long	-	-
Reserved	Reserved	3109	Long	-	-

Integrated Block – Utility (U):

- Function Code: 03H Read
- Number of registers: 20
- No scaling required
- Read as block only

Table 6-13: Integrated block – Utility (U)

Parameter	Description	Address	Type	EM 6438	EM 6436dual
kVAh U	Apparent energy, utility	3121	Float	✓	✓
Wh U	Active energy, utility	3123	Float	✓	✓

Reserved	Reserved	3125	Float	-	-
Reserved	Reserved	3127	Float	-	-
Reserved	Reserved	3129	Float	-	-
On sec U	On seconds, utility	3131	Float	✓	✓
Reserved	Reserved	3133	Float	-	-
Reserved	Reserved	3135	Float	-	-
Reserved	Reserved	3137	Long	-	-
Runsecs U	Run seconds, utility	3139	Long	✓	✓

Integrated Block – Generator (G):

- Function Code: 03H Read
- Number of registers: 20
- No scaling required
- Read as block only

Table 6-14: Integrated block – Generator (G)

Parameter	Description	Address	Type	EM 6438	EM 6436dual
kVAh G	Apparent energy, generator	3151	Float	✓	✓
Wh G	Active energy, generator	3153	Float	✓	✓
Reserved	Reserved	3155	Float	-	-
Reserved	Reserved	3157	Float	-	-
Reserved	Reserved	3159	Float	-	-
On sec G	On seconds, generator	3161	Float	✓	✓
Reserved	Reserved	3163	Float	-	-
Reserved	Reserved	3165	Float	-	-
Reserved	Reserved	3167	Long	-	-
Runsecs G	Run seconds, generator	3169	Long	✓	✓

Total Integrated Block:

- Function Code: 03H Read
- Number of registers: 20
- No scaling required
- Read as block only

Table 6-15: Total integrated block

Parameter	Description	Address	Type	EM 6438	EM 6436dual
kVAh (U + G)	Total apparent energy	3181	Float	✓	✓
Wh (U + G)	Total active energy	3183	Float	✓	✓
Reserved	Reserved	3185	Float	-	-
Reserved	Reserved	3187	Float	-	-
Reserved	Reserved	3189	Float	-	-
On sec (U + G)	Total on seconds	3191	Float	✓	✓
Reserved	Reserved	3193	Float	-	-
Reserved	Reserved	3195	Float	-	-
Reserved	Reserved	3197	Long	-	-
Runsecs (U + G)	Total run seconds, generator	3199	Long	✓	✓

Demand Block:

This block is applicable only for the dual energy meters with demand option.

- Function Code: 03H Read
- Number of registers: 22
- No scaling required
- Read as block only

Table 6-16: Demand block

Parameter	Description	Address	Type	EM 6438	EM 6436dual
Reserved	Reserved	3721	Long	-	-
Reserved	Reserved	3723	Float	-	-
Reserved	Reserved	3725	Float	-	-
Reserved	Reserved	3727	Float	-	-
Reserved	Reserved	3729	Float	-	-
Reserved	Reserved	3731	Float	-	-
Reserved	Reserved	3733	Float	-	-
Parameter	Description	Address	Type	EM 6438	EM 6436dual
Present demand	Present demand	3735	Float	✓	✓
Rising demand	Rising demand	3737	Float	✓	✓
Time remaining	Time remaining	3739	Long	✓	✓
Reserved	Reserved	3741	Float	-	-

Note: The address 3741 is overlapped between the Demand and Max Demand blocks.

Max Demand Block:

This block is applicable only for dual energy meters with demand option.

- Function Code: 03H Read
- Number of registers: 36
- No scaling required
- Read as block only

Table 6-17: Max demand block

Parameter	Description	Address	Type	EM 6438	EM 6436dual
MaxDM U	Maximum demand, utility	3741	Float	✓	✓
MaxDMTime U	Maximum demand occurrence time, utility	3743	Long	✓	✓
Reserved	Reserved	3745	Float	-	-
Reserved	Reserved	3747	Long	-	-
Reserved	Reserved	3749	Float	-	-
Reserved	Reserved	3751	Long	-	-
Reserved	Reserved	3753	Float	-	-
Reserved	Reserved	3755	Long	-	-
Reserved	Reserved	3757	Float	-	-
Reserved	Reserved	3759	Long	-	-
Reserved	Reserved	3761	Float	-	-
Reserved	Reserved	3763	Long	-	-
Reserved	Reserved	3765	Float	-	-
Reserved	Reserved	3767	Long	-	-
Reserved	Reserved	3769	Float	-	-
Reserved	Reserved	3771	Long	-	-
Reserved	Reserved	3773	Float	-	-
Reserved	Reserved	3775	Long	-	-

Note: The address 3741 is overlapped between the Demand and Max Demand blocks

Old Integrated Block – Utility (U):

- Function Code: 03H Read
- Number of registers: 20
- No scaling required
- Read as block only

Table 6-18: Old integrated block – utility (U)

Parameter	Description	Address	Type	EM 6438	EM 6436 dual
OLD kVAh U	Old apparent energy, utility	3122	Float	✓	✓
OLD Wh U	Old active energy, utility	3124	Float	✓	✓
Reserved	Reserved	3126	Float	-	-
Reserved	Reserved	3128	Float	-	-
Reserved	Reserved	3130	Float	-	-
OLD On sec U	Old on seconds, utility	3132	Float	✓	✓
Reserved	Reserved	3134	Float	-	-
Reserved	Reserved	3136	Float	-	-
Reserved	Reserved	3138	Long	-	-
OLD Runsecs U	Old run seconds, utility	3140	Long	✓	✓

Old Integrated Block – Generator (G):

- Function Code: 03H Read
- Number of registers: 20
- No scaling required
- Read as block only

Table 6-19: Old integrated block – generator (G)

Parameter	Description	Address	Type	EM 6438	EM 6436 dual
OLD kVAh G	Old apparent energy, generator	3152	Float	✓	✓
OLD Wh G	Old active energy, generator	3154	Float	✓	✓
Reserved	Reserved	3156	Float	-	-
Reserved	Reserved	3158	Float	-	-
Reserved	Reserved	3160	Float	-	-
OLD On sec G	Old on seconds, generator	3162	Float	✓	✓
Reserved	Reserved	3164	Float	-	-
Reserved	Reserved	3166	Float	-	-
Reserved	Reserved	3168	Long	-	-
OLD Runsecs G	Old run seconds, generator	3170	Long	✓	✓

Old Total Integrated Block:

- Function Code: 03H Read
- Number of registers: 20
- No scaling required
- Read as block only

Table 6-20: Old total integrated block

Parameter	Description	Address	Type	EM 6438	EM 6436 dual
OLD kVAh (U + G)	Old total apparent energy	3182	Float	✓	✓
OLD Wh (U + G)	Old total active energy	3184	Float	✓	✓
Reserved	Reserved	3186	Float	-	-
Reserved	Reserved	3188	Float	-	-
Reserved	Reserved	3190	Float	-	-
OLD On sec (U + G)	Old total on seconds	3192	Float	✓	✓
Reserved	Reserved	3194	Float	-	-

Reserved	Reserved	3196	Float	-	-
Reserved	Reserved	3198	Long	-	-
OLD Runsecs (U + G)	Old total run seconds, generator	3200	Long	✓	✓

Phase Angle Block:

- Function Code: 03H Read
- Number of registers: 18
- No scaling required
- Read as block only

Table 6-21: Phase angle block

Parameter	Description	Address	Type
Vn	Neutral voltage	3701	Float
An	Neutral current	3703	Float
V1	Voltage phase angle, phase 1	3705	Float
V2	Voltage phase angle, phase 2	3707	Float
V3	Voltage phase angle, phase 3	3709	Float
A1	Current phase angle, phase 1	3711	Float
A2	Current phase angle, phase 2	3713	Float
A3	Current phase angle, phase 3	3715	Float
RPM	Rotations per minute	3717	Float

Note: The parameters V1, V2, V3 (voltage phase angles) and neutral voltage are available only through communication.

Setup Block:

- Function Code: 03H Read, 10H Write
- Number of registers: 40/42
- No scaling required
- Read and write as block only

Table 6-22: Setup block

Parameter	Description	Address	Type	Range	Default value
A.Pri	Current primary	0101	Float	1.0 to 99 k	100.0
A.Sec	Current secondary	0103	Float	1.0 to 6.5	5.000
V.Pri	Voltage primary	0105	Float	100.0 to 999 k	415.0
V.Sec	Voltage secondary	0107	Float	50.00 to 601.0	415.0
SYS	System Configuration	0109	Float	2.0 to 6.0 2.0 – Delta 3.0 – Star 4.0 – Wye 5.0 – 2 Ph 6.0 – 1 Ph	3.000
LABL	Phase Labeling	0111	Float	0.0 to 4.0 0.0 – 123 1.0 – ABC 2.0 – RST 3.0 – PQR 4.0 – RYB	0.000
VA Fn	VA Function selection	0113	Float	0.0 to 1.0 0.0 – 3D 1.0 – Arth	0.000

D Sel	Demand Selection	0115	Float	0.0 to 1.0 0.0 – Auto 1.0 – User	0.000
D Par	Demand parameter	0117	Float	0.0 to 2.0 0.0 – VA 1.0 – W 2.0 A	0.000
Parameter	Description	Address	Type	Range	Default value
D Prd	Demand period	0119	Float	1.0 to 6.0 1.0 – 5 Min 2.0 – 10 Min 3.0 – 15 Min 4.0 – 20 Min 5.0 – 25 Min 6.0 – 30 Min	3.000
BAUD	Baud rate	0121	Float	3.0 to 5.0 3.0 – 4800 4.0 – 9600 5.0 – 19200	5.000
PRTY	Parity and stop bit	0123	Float	0.0 to 5.0 0.0 – Even 1 1.0 – Even 2 2.0 – Odd 1 3.0 – Odd 2 4.0 – No 1 5.0 – No 2	0.000
ID	Unit ID	0125	Float	1.0 to 247.0	1.000
F.S%	% Full scale	0127	Float	1 to 100	100.0
OFLo	Overflow parameter selection	0129	Float	0.0 – Wh 1.0 – VAh 2.0 – Wh E 3.0 – VAh E	2.0 - Wh E
POLE	Number of poles for RPM	0131	Float	1.0 to 8.0 1.0 – 2 2.0 – 4 3.0 – 6 4.0 – 8 5.0 – 10 6.0 – 12 7.0 – 14 8.0 – 16	2.000
PWD	Password	0133	Float	1000	1000
Reserved	Reserved	0135	Float	-	2.0
Reserved	Reserved	0137	Float	-	4126
Reserved	Reserved	0139	Float	-	0.0
F.SEQ	Float byte sequences	0141	Float	1.0 to 2.0 1.0 – 4321 2.0 – 2143	2.0

Note: For efficient communication setup, read the setup parameters first and then edit the required setup parameter value.

Clear Block:

- Function Code: 10H Write
- Number of registers: 2
- No scaling required
- Write as block only

Table 6-23: Clear block

Parameter	Description	Address	Type	Range
CLR_INTG_DMD_SE TDEFAULT	INTG and demand clearing and setting up the setup default	0311	Long	1 - INTG and MD Clear 2 - MD Clear 256 - Setup default

Note: For setup default, the power meter will send an exception for values other than 256.

Model Info Block:

- Function Code: 03H Read
- Number of registers: 14
- No scaling required
- Read as block only

Table 6-24: Model Info Block

Parameter	Description	Address	Type	Range
Reserved	Reserved	0081	Long	
Reserved	Reserved	0083	Long	
Model Version	Model, Options and version numbers	0085	Long	Bits 30 to 24 for model number; Bits 23 to 16 for options Bits 15 to 0 for version number E.g., PM1200 model no is 22
Reserved	Reserved	0087	Long	
Reserved	Reserved	0089	Long	
Reserved	Reserved	0091	Long	
Reserved	Reserved	0093	Long	

Model Register Details

This section explains about the model register and helps you to understand the model number, version number, and options.

The following figure explains how the bits are organized in the model register.

Figure 6-4: Bits in model register

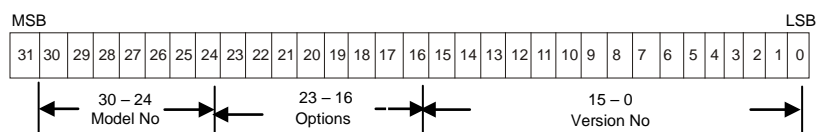

Meter Model and Number: The following table bitwise explanation for Meter model and number.

Table 6-25: Meter model and number

Meter Model	Model Number 5A Meter	Model Number 1A Meter	Option bit wise
EM6436	06 (0x06)	134 (0x86)	-
EM6438	07 (0x07)	135 (0x87)	-
EM6436-3	09 (0x09)	137 (0x89)	-
EM6436dual	10 (0x0A)	138 (0x8A)	-

Model options description: The following table gives the model options bitwise description.

Table 6-26: Model options description

Bit23	Bit22	Bit21	Bit20	Bit19	Bit18	Bit17	Bit16	Remarks
0	0	0	0	0	0	0	0	No options available
0	0	0	0	0	0	0	1	Imp/Exp option available
0	0	0	0	0	0	1	0	DM option available
0	0	0	0	0	0	1	1	Imp/Exp and DM option available
0	0	0	0	0	1	0	0	THD option available
0	0	0	0	0	1	0	1	Imp/Exp and THD available
0	0	0	0	0	1	1	0	DM and THD available
0	0	0	0	0	1	1	1	Imp/exp, DM and THD available

Interpretation of firmware version number: The following steps clearly explain how to interpret the firmware (FW) version number.

1. Convert the hexadecimal values both MSB and LSB into decimal values.
2. Apply the formula ((MSB*256) +LSB).
3. The resulting value will be 30400 for the hexadecimal value 0x76 0xC0.
4. Insert a **0** before the result and parse it from the right with two digits each.
5. The result will be the FW version = 03.05.01.

Table 6-27: Firmware version interpretation

	MSB	LSB
Hexadecimal	0x76	0xC0
Decimal	118	192
VALUE=((MSB*256)+LSB)	30400	
FW Version	03.05.01	

Note: Firmware version representation only. To determine your power meter’s present firmware version, refer the diagnostic page in the power meter. See Dual Source Energy Meters Menu Hierarchy”, on page 30 to navigate through the diagnostic page.

NOTE:

- Most of the reserved and unavailable parameters return zero value.
- The SCADA software must support register blocks consisting of different data types (integers and floats) to transfer of whole block.
- Each Modbus register size is 16 bits. All the dual energy meter readings are 32 bits. Therefore, each dual energy meter reading occupies two consecutive Modbus registers. For example, VA parameter absolute address is 3901. It occupies both 3901 and 3902 Modbus registers.
- Address configuration: All addresses are in decimal. Some SCADA software supports Modbus register address instead of absolute register address. In this case add 40000 to the above address and use it. For example, VA parameter absolute address is 3901. Modbus address can be 43901 (40000+3901).
- Phase Angle Block: Voltage phase angles (0,120,240) are hard coded (not measured). Hence, these values are also available in communication in the absence of input signals; however, these voltage phase angles are not available in the dual energy meter display.
- TURBO, and Percentage of Load Blocks: These parameters can be read individually or as a block
- TURBO block: 50 parameters maximum
- Percentage of Load block: 5 parameters maximum
- All dual energy meters addresses should be set between 1 and 247.
- All dual energy meters should have uniform communication settings like Baud rate, parity and

stop bit.

- *Use Diagnostic mode display in the dual energy meter to analyze the problem in communication.*
- *Error: u – Invalid unit ID*
 - A – Invalid Address*
 - c – CRC error (cyclic redundancy checking)*
 - t – Transmitting*
 - r – Receiving*
 - F – Invalid function code*
 - o – Parity, framing or overrun error*
 - O- Buffer overflow*

Chapter 7: Maintenance and Troubleshooting

Introduction

This chapter describes information related to maintenance of your dual energy meter.

The dual energy meter does not contain any user-serviceable parts. If the dual energy meter requires service, contact your local sales representative. Do not open the dual energy meter. Opening the dual energy meter voids the warranty.

CAUTION

HAZARD OF EQUIPMENT DAMAGE

- Do not perform a Dielectric (Hi-Pot) or Megger test on the dual energy meter, test voltages may damage the dual energy meter.
- Before performing Hi-Pot or Megger testing on any equipment in which the dual energy meter is installed, disconnect all input and output wires to the dual energy meter.

Failure to follow these instructions will result in equipment damage.

Troubleshooting

The information in Table 7–1 describes potential problems and their possible causes. It also includes possible checks to perform or solutions to the problems. After referring to this table, if you cannot resolve the problem, contact your local Schneider Electric sales representative for assistance.

⚠ DANGER

HAZARD OF ELECTRIC SHOCK, EXPLOSION, OR ARC FLASH

- Apply appropriate personal protective equipment (PPE) and follow safe electrical practices. For example, in the United States, see NFPA 70E.
- This equipment must be installed and serviced only by qualified personnel.
- Turn off all power supplying this equipment before working on or inside.
- Always use a properly rated voltage sensing device to confirm that all power is off.
- Carefully inspect the work area for tools and objects that may have been left inside the equipment.
- Use caution while removing or installing panels so that they do not extend into the energized bus; avoid handling the panels, which could cause personal injury.

Failure to follow these instructions will result in death or serious injury.

Table 7-1: Trouble shooting

Potential Problem	Possible Cause	Possible Solution
The data being displayed is inaccurate or not what you expect	Incorrect setup values	Check that the correct values have been entered for dual energy meter setup parameters (CT and PT ratings, system type, and so on). See “PROG menu - Setup” on page 19 for setup instructions.
	Usage of protection class (10P10 etc.) CTs/PTs	Use instrument class 1 or better CTs/PTs, which will have better accuracy than the protection class CTs/PTs.
	Improper wiring	Check whether all the PTs and CTs are connected properly (proper polarity is observed) and that they are energized. Check shorting terminals. See “Connection diagrams” on page 46 for more information.
Incorrect power readings	CTs are incorrectly wire	For proper measurements, the phase identification as well as the polarity of the current signals must be correct. Check and correct the CT connections.
Active Power (W) reading is negative	CT may be reversed	Check and correct the CT connections.

Potential Problem	Possible Cause	Possible Solution
The display went blank suddenly	Over voltage/temperature	Interrupt the power supply or reduce the voltage or temperature within the limit.
	Fuse connection	Check whether a fuse with rating of 0.25 A is connected on each voltage input. If not connect the 0.25 A rated fuse to the voltage input.
The dual energy meter stopped communication abruptly	Communications lines are improperly connected.	Verify the dual energy meter communications connections. See "Chapter 6 – Data communication" on page 51 for more information.
	Over voltage/temperature	Interrupt the power supply or reduce the voltage or temperature within the allowable limits.
Incorrect Load bar indication	Incorrect F.S% selection	Select the full scale load percentage setting as per your circuit.
The dual energy meter is over heated	Lack of sufficient air for cooling	Provide sufficient space all around the dual energy meter. Separate the dual energy meter from other equipment for cooling air.

Disposal and Recycle

Dispose of or recycle the device in accordance with the applicable laws and regulations in your country.

To Disassemble

1. Ensure to shut down the device, before you begin to disassemble the meter.
2. Disconnect all the connected terminals from the meter.
3. Loosen the mounting clamps at the back of the meter.
4. Remove the side clamps on both the sides of the meter by sliding them forward.
5. Remove the meter from the panel-cutout carefully.

Note: For the use of proper tool, refer "Electrical Installation" on page 40 for more information

Appendix A – Technical Data

Accuracy

Table A-1: Accuracy

Measurement	Accuracy % of Reading*		
	Class 1.0	Class 0.5S	Class 0.2
Voltage LN per phase and average	1.0	0.5	0.2
Voltage LL per phase and average	1.0	0.5	0.5
Amp per phase and average	1.0	0.5	0.2
Frequency	0.1	0.1	0.1
Total Active power, (kW)	1.0	0.5	0.2
Total Apparent power, (kVA)	1.0	0.5	0.2
Active energy (kWh.U, kWh.G)	1.0	0.5	0.2
Apparent energy (kVAh.U, kVAh.G)	1.0	0.5	0.2

NOTE:

- Voltage, current, frequency parameters are applicable only for EM6436dual dual source energy meter.
- 5A meter - Additional error of 0.05 % of full scale for meter input current below 100 mA.
- 1A meter - Additional error of 0.05 % of full scale for meter input current below 20 mA.
- PF error limit is same as W error limit in %.
- *In Delta mode configuration the accuracy will be 1.0% of reading.

Auxiliary supply (Control power)

The dual energy meter needs a single-phase AC or DC control supply to power its internal electronics.

Range: 44 to 300 VAC/DC.

Burden (load): 3 VA max on Auxiliary supply.

Front Panel Display

- Brilliant three lines four digit (digit height 14.2 mm/0.56 in.) per line, high readability alpha numeric LED display with auto scaling capability for Kilo, Mega, Giga.
- The display provides the user access to all phase voltages (phase to neutral and phase to phase), currents (per phase and average), Watts, VA, power factor, frequency, kWh (U and G), and kVAh (U and G).
- The dual energy meter (EM6436dual) displays average volts, amps, and frequency simultaneously.
- Load bar graph for the indication of consumption in terms of % amperes total.
- Set of four red LED's in the load bar start blinking when the load is greater than 120%, to indicate overload.
- Easy setup through keys located on the faceplate for common configuration parameters.
- Password protection for setup parameters.
- User-selectable default display page through keypad lock.

Installation and Input Ratings

- Auto-ranging voltage inputs should allow direct connection up to 347 VLN/600VLL AC systems, no PTs (VTs) required up to 600 VLL phase to phase)
- Supports the following configurations (field configurable):
Direct 4-wire Wye (Star); 3-wire Wye (Star); 3-wire Delta; 2-phase 3-wire (2-phase); and single-phase
- 3-phase voltage, and current inputs
- Volts : 46 to 347 VAC phase-neutral, 80 to 600 VAC phase-phase,
Overload: Continuous 600 VLL with full accuracy, 750 VLL Max, Hz. 50 / 60
- Amperes: 5 mA (starting) to 6 A, Overload: 10 A continuous, 50 A for three seconds
- User programmable for 5 A or 1 A secondary CTs
- Burden (Load): Less than 0.2 VA per Volt / Ampere input
- Frequency (both auxiliary and input): 50 / 60 Hz, 45 to 65 Hz

Environmental Conditions

- Sealed dust- proof construction. Meets IP51 for the front panel and IP40 for rear panel
- Operating temperature: -10 °C to 60 °C , (14 °F to 140 °F)
- Storage temperature: -25 °C to 70 °C, (-13 °F to 158 °F)
- Humidity: 5% to 95%, non-condensing
- Altitude ≤ 2000m

Construction

- Self-extinguishable V0 plastic, double insulation at accessible areas
- Pollution Degree II
- Measurements Category III



Dimensions and Shipping

- Basic unit installed depth 83 mm with 92 x 92 mm panel cut-out, flush mount.
- Bezels dimension 96 x 96 mm. Panel Cut-out 92 x 92 mm.
- Weight 400 gms approx unpacked, 500 gms approx shipping. See “Mechanical Installation” on page 37 for more information.





Appendix B: SIM (simulation) Mode

The dual energy meters are provided with SIM mode for demo and exhibition display, where the user can see the functioning of the dual energy meter without any input signals. The dual energy meter will show a fixed voltage, current, frequency, and 0.5PF. Power and energy parameters are calculated based on the V, A, and PF displayed.

To Enter SIM mode

- Keep the  pressed, while powering up the dual energy meter. The display shows **RUN**.
- Press . The display shows **SIM**.
- Press . The display shows **RMS SIM**. You have successfully entered the SIM mode of the dual energy meters.

To Exit from SIM mode

- Press and hold the , until you reach the RMS page.
- Press . The display shows **SIM**.
- Press . The display shows **RUN**.
- Press . The display shows **RMS** indicating the exit from SIM mode

Appendix C: Glossary

Terms

Auto (sliding block): An interval selected from five to 30 minutes. The dual energy meter calculates and updates the demand every 15 seconds.

Baud rate: Specifies how fast data is transmitted across a serial network port.

Communications link: A chain of devices connected by a communications cable to a communications port.

Current Transformer (CT): Current transformers for current inputs.

Demand: Average value of a quantity, such as power, over a specified interval of time.

Firmware: Operating system within the dual energy meter.

Float: A 32-bit floating point value returned by a register (See “Data Address” on page 58 for more information).

Forward: Importing the power into the plant/grid.

Frequency: Number of cycles in one second.

Line-to-line voltages: Measurement of the RMS line-to-line voltages of the circuit.

Line-to-neutral voltages: Measurement of the RMS line-to-neutral voltages of the circuit.

LOCK: Default display page lock (See “Default display (View) page” on page 12 for more information).

Long: A 32-bit value returned by a register (See “Data Address” on page 58 for more information).

Maximum demand: Highest average load during a specific time interval.

Nominal: Typical or average.

Parity: Refers to binary numbers sent over the communications link. An extra bit is added so that the number of ones in the binary number is either even or odd, depending on your configuration. It is used to detect the errors during the transmission of data.

Power factor: True power factor is the ratio of real power to apparent power using the complete harmonic content of real and apparent power.

Reverse: Exporting the power from the plant/grid.

RMS: Root mean square. The dual energy meters are true RMS sensing devices.

Run mode: This is the normal operating mode of the dual energy meter, where the readings are taken.

ULOC: Default display page unlock (See “Default display (View) page” on page 12 for more information)

User (fixed block): An interval selected between five to 30 minutes. The dual energy meter calculates and updates the demand at the end of each interval.

Abbreviations

%A FS	% Amperes full scale
A, Amps	Amperes
A.PRI	Current primary winding
A.SEC	Current secondary winding
Avg	Average
CLR	Clear
CT	Current transformer
Dia, DIAG	Diagnostic
ft	Feet/foot
F.Seq	Float Byte Sequence
FW	Firmware
G	Generator
Hz	Hertz
ID	Identity
in.	Inch
INTG	Integrator
IP	Ingress protection
kVAh	Kilo volt-ampere hour
kWh	Kilo watt hour
MD	Maximum demand
Min	Minimum
ms	Milliseconds
O.F	Overflow
PF	Power factor
PT	Potential transformer
R.d	Rising demand
SYS	System configuration
U	Utility
ULOC	Unlock
Unb	Unbalance
V	Voltage
VA	Apparent power
VAh	Apparent energy
V.PRI	Voltage primary winding
V.SEC	Voltage secondary winding
VT	Voltage transformer
W	Active power
Wh	Active energy

INDEX

- AC Power Measurement
 - 3D kVA Measurement, 36
 - Consumption and Poor PF, 36
- AC Power Measurement
 - Three phase systems, 35
- Auto scroll
 - Within page group, column of pages and Turbo pages, 12
- Block parameter address
 - B Phase RMS block, 61
 - Clear block, 66
 - Max Demand block, Old Forward Integrated block, 63
 - Model Info block, 67
 - Old Reverse Integrated Block, Old Total Integrated block, 64
 - Phase angle block, Setup block, 64
 - Total Integrated block, Demand block, 62
 - Total RMS block, R phase RMS block, 59
 - Y Phase RMS block, 60
- Communication Test, 56
- Connections
 - Connection diagram symbols, 46
 - Delta connection, 47
 - Open delta connection, 47
- Data Address
 - Block parameter address, 59
 - Individual parameter address, 58
- Data communication, 51
 - Daisy chaining devices to the power meter, 53
- Data Communication
 - Data formats and settings, 54
- Default display (View) page
 - Display lock and unlock, 12
- Demand Power Calculation Methods
 - Auto - Sliding block, User - Fixed block, 29
- Disassemble, 73
- Disposal and Recycle, 73
- Electrical Installation, 40
- Energy Integrator
 - Integrator overflow, OLD data register, 27
- Front panel
 - Kilo, Mega, Giga and negative indicators, 8
- Front Panel
 - LED display, Load bar, 8
- Keys
 - Left, Right, Up, Down keys, 10
 - Operation, 11
- Maintenance and Troubleshooting, 71
- Mechanical Installation
 - Panel considerations and Environment, 38
- Mechanical Installation, 37
- PM1000 series power meters product description, 7
- PROG menu - Setup
 - List of setup parameters in View & Edit modes, 22
 - Quick setup - While powering on, 19
 - Setup entru in View mode, 21
 - Setup entry in Edit mode, 21
 - Setup parameters editing, 24
- Rear Panel, 13
- Safety
 - Precautions, 17
 - Symbols, 3
- Sim (Simulation) Mode, 77
- Technical specifications, 15
- Total RMS block, 59
- TURBO Key, 10

Schneider Electric India Pvt Ltd
44 P, Electronics City, East Phase,
Hosur Road,
Bangalore - 560 100, India

email :customercare.in@schneider-electric.com
Toll free help desk number:
1800 425 4272, 1800 103 0011
www.schneider-electric.co.in

Conzerv, PowerLogic, and ION Enterprise are either trademarks or registered trademarks of Schneider Electric.

Electrical equipment should be installed, operated, serviced, and maintained only by qualified personnel. No responsibility is assumed by Schneider Electric for any consequences arising out of the use of this material.

NHA12537-03 © 2015 Schneider Electric. All rights reserved. 07/2015